



GTD - INCA

User Manual

V4.9.0

Legal Aspects

Use of the software and of the present software manual is submitted to a license agreement to be accepted before the software installation on a computer.

All suggestion or error concerning the software or this software manual can be sent to:

Airbus Defence and Space

For the attention of Mr. M. LEPILLIEZ

Z.I. du Palays

31 rue des Cosmonautes

31402 TOULOUSE CEDEX 4

FRANCE

This document and the information it contains are property of Airbus Defence and Space. It shall not be used for any purpose other than those for which it was supplied. It shall not be reproduced or disclosed (in whole or in part) to any third party without Airbus Defence and Space prior written consent.

GTD USER MANUAL

This Manual describes the GTD-INCA applications and their integration into the SYSTEMA v4 framework.

For the general usage of SYSTEMA,
please refer to the SYSTEMA User Manual

Contents

Introduction.....	7
1 Overview.....	8
GTD - INCA.....	8
SYSTEMA Interface	8
2 Process 9	
General Process.....	9
GTD 10	
3 GTD Introduction.....	11
What is GTD.....	11
Antennas modelling.....	12
Overview of the Method	13
The GTD Ray-Tracing	14
4 GTD Input Model & Meshing	15
4.1 The GTD Model	15
Geometry.....	15
Applicative Properties.....	15
4.2 The GTD Meshing	20
Geometric Meshing	20
GTD Specific Items	20
4.3 Antennas Definition	20
Common Properties	21
Cardioid Shaped.....	22
Standard Feed.....	24
Measured Pattern	26
Envelop Pattern.....	29
Spherical Wave Expansion.....	30
4.4 Targets Definition.....	30
Uniform Target	31
Aperture Target	31
5 GTD Analysis	34
5.1 Process Overview.....	34
5.2 GTD Ray-Tracing Module.....	35
GTD-RT Outputs	37

5.3 GTD Antenna Decoupling Module	37
GTD- Antenna Dcp Outputs	37
5.4 GTD Target Module	39
GTD- Target Mapping Outputs	39
5.5 GTD Far Field Module	40
GTD- Far Field Outputs	41
6 Results Display in SYSTEMA	43
Target Mapping	43
Ray Display	44
INCA 46	
7 INCA Introduction	47
What is INCA.....	47
The OCT methodology	47
8 INCA Pre-Processor Input Model & Meshing	48
8.1 The INCA Geometrical Model	48
Geometry.....	48
Applicative Properties.....	48
Material Database	49
8.2 The INCA Meshing	49
Geometric Meshing	49
INCA Specific Items	49
Cavities Definition.....	50
Apertures Definition	50
9 INCA Pre-Processor Analysis	51
9.1 The INCA Pre-processor Process	51
9.2 Outputs 52	
9.3 Post-Processing the results	52
10 INCA Solver Input	53
10.1 The INCA Mathematical Model	53
Model Overview.....	53
Generic rules of the MM format	54
Antennas	54
Materials.....	55
Cavities.....	55
Apertures.....	55
11 INCA Solver Analysis	56
11.1 The INCA Solver Process	56
11.2 The INCA Solver Outputs	57

12 INCA Theoretical Background.....	59
12.1 Injected Power through Apertures	59
Injected Power.....	59
Circular Aperture	60
Rectangular Aperture	62
12.2 Cavity insertion loss assessment	63
Received power assessment in one cavity.....	64
Received E-field assessment in one cavity	66
Received Power assessment in several cavities	67

Introduction

1 Overview

GTD - INCA

The **GTD-INCA** applications deal with electromagnetism problems:

The **GTD** tool consists of a complete radio-frequency prediction tool for large structure. It is used to propagate the electromagnetism field from the antenna sources to different points of interests such as:

- **other antennas:** to compute the decoupling between them
- **targets:** to evaluate the incoming field and decoupling at a specific location
- **far sphere:** to evaluate the antenna pattern

The propagation of the field is made by a ray-tracing method and uses the Geometrical Theory of Diffraction.

The **INCA** tool computes the internal cavity RFE-field due to the external apertures illumination from the antennas (computed with **GTD**) and the internal RF leaks. The methodology used is the Oversized Cavity Theory, considering the satellite cavities as multimode cavities (very large dimensions with respect to operating wavelength) similar to mode stirring chamber (quasi thermodynamic RF conditions, producing homogeneous and isotropic field).

SYSTEMA Interface

GTD and **INCA** are based on the **SYSTEMA** framework allowing building or importing the geometry in a very powerful 3D multidisciplinary framework.

The *Modeler* and *Processing* tabs of **SYSTEMA** are used by **GTD** and **INCA**. The others (*trajectory*, *Kinematics* and *Mission*) are not.

2 Process

General Process

In order to perform an analysis, all the required inputs shall be properly set within the **SYSTEMA** environment.

To execute a **GTD** or the **INCA** pre-processor module, a **SYSTEMA** v4 geometry associated with a meshing structure shall exist.

The geometry contains the geometrical description of the model plus its physical properties. The geometrical description can be imported from different format (**SYSTEMA** v3: *SYSEXP* or *SYSBAS* – Mechanical tool: Nastran *bdf* – CAD tool: *Step AP203* – Other graphical tool: *WRML*) or may be built entirely within the geometrical modeler. This modeler is explained details in the “**SYSTEMA** User's Manual”.

The meshing structure converts the geometry to calculation elements called mesh. In the case of **GTD** and **INCA**, it is not necessary to sub-mesh the geometry except in the case of **GTD** target for which a mapping of results is required (several computation elements are then required on the geometrical element). However, even if no sub-mesh is required, the identification of the shapes by a numbering is always required by the computation. Then the meshing structure is always mandatory for the computation.

Besides the meshing and numbering aspects, the meshing tree contains also additional elements which may be required by the computation. Those “specific items” are used to complete the description given by the geometry or meshing and may also specialize elements. The specific items of **GTD** indicate the antennas and targets properties. In **INCA** they indicate the antennas, cavities and apertures.

Once the model and meshing have been correctly set, the process can be created in the Processing tab of **SYSTEMA**. The options dedicated to the computation are editable from the process placed on the diagram. It is also possible to modify the location of the outputs from the “Edit” button beside the current specified path, just below the diagram.

GTD

3 GTD Introduction

What is GTD

The radio frequency (RF) analysis of satellites is one of many important steps required to ensure a successful mission. For directive antennae, the satellite structure and nearby payloads may often be neglected, but for low-gain antennae and omnidirectional antennae, the structure may influence the radiation characteristics substantially.

Therefore it is of a great interest for these types of antennae, to have the capability to compute the interfered antenna pattern, for an antenna mounted on a satellite structure.

In addition to the antenna pattern, this software enables the calculation of antenna to antenna coupling due to the structure, which is very important for the positioning of antennae, and the study of the electromagnetic compatibility between them. The field computation on surfaces of the structure or on virtual surfaces is also available in this new version.

The RF analysis is based on the Geometrical Theory of Diffraction (GTD) which assumes high frequency. The ray-tracing may be carried out in two essentially different ways. The traditional backward ray tracing determines the ray paths when the source position, the scattering objects and the far field direction are given. Alternatively, the forward ray tracing principles of CAD applications may be applied. A large number of rays are then emitted from the source in all directions and each ray is followed to its final destination. The **GTD** software makes use of this latter efficient and powerful technique.

In this version of the software, multiple reflected rays, as well as multiple diffracted rays are handled for all planed and curved **SYSTEMA** surfaces. The number of reflections and diffractions for a single ray is limited to 2, creeping rays on plane surfaces are also taken into account.

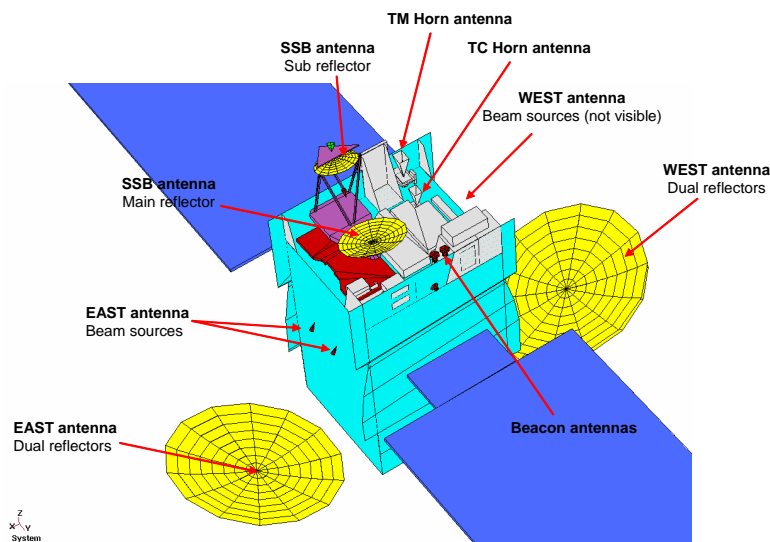

Example of a mechanical model used for the GTD computation

The antenna to antenna coupling allows computing the coupling coefficient between two antennas. In a first step, the “ray tracing” determines the coupling ray paths. In a second

step, the coupling value is calculated by field propagation along the rays using a complex or RSS field summation.

GTD offers a great help to the engineer for the RF System analysis like the positioning of antennae on the structure, the detection of interaction problems very early in the program and the prediction of the antenna pattern.

Antennas modelling

The GTD tool is able to model all main antennas currently used on satellites by several means.

It is able to load the measured (or simulated gain) provided by Antenna Supplier under φ cuts format (typically $\varphi = 0^\circ, 45^\circ, 90^\circ$ & 135° with θ within $[-180^\circ; 180^\circ]$), or under Spherical Wave Expansion files (SWE). This is particularly well fitted to TCR antennas, Horns and Payload Feeds.

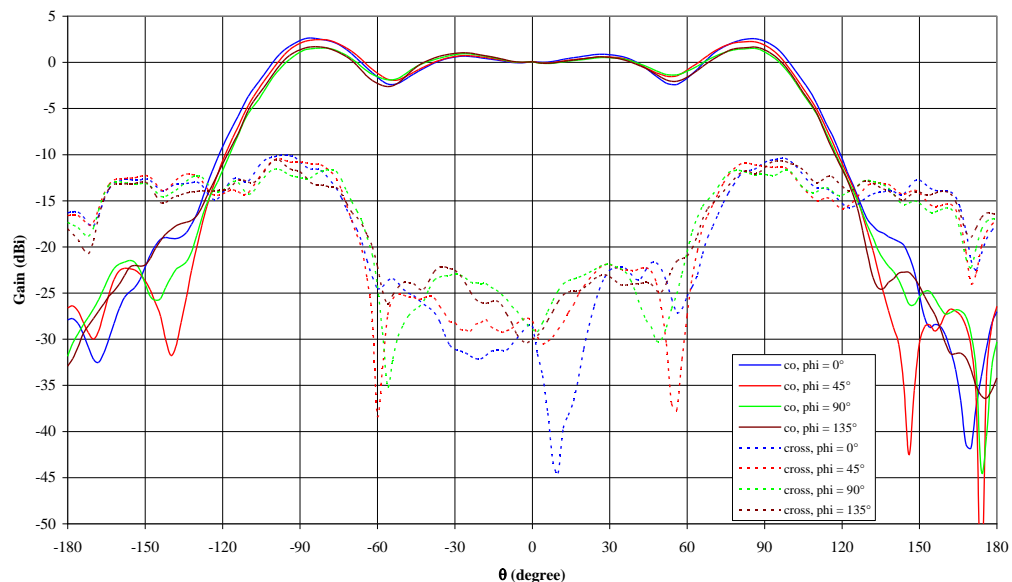

Example of measured gain corresponding to GTD input

It can simulate Reflector Antennas using the parabolic reflectors combined with the measured gain for the Feed. The three classical Reflector Antennas can be modeled under GTD:

- centered parabolic antennas
- Single offset antennas
- Gregorian Antennas (hyperbolic sub-reflector approximated by Best Fit Parabola)

It offers a database of theoretical antennas (half wave dipole, helix antenna, circular & rectangular apertures, standard feeds, cardioids).

For Decoupling Analysis, it integrates Feed envelop modeler, for Main Lobe (Gaussian Part) & back radiation optimization. It also calculates the integrated gain over 4π steradians in view to avoid unrealistic antennas.

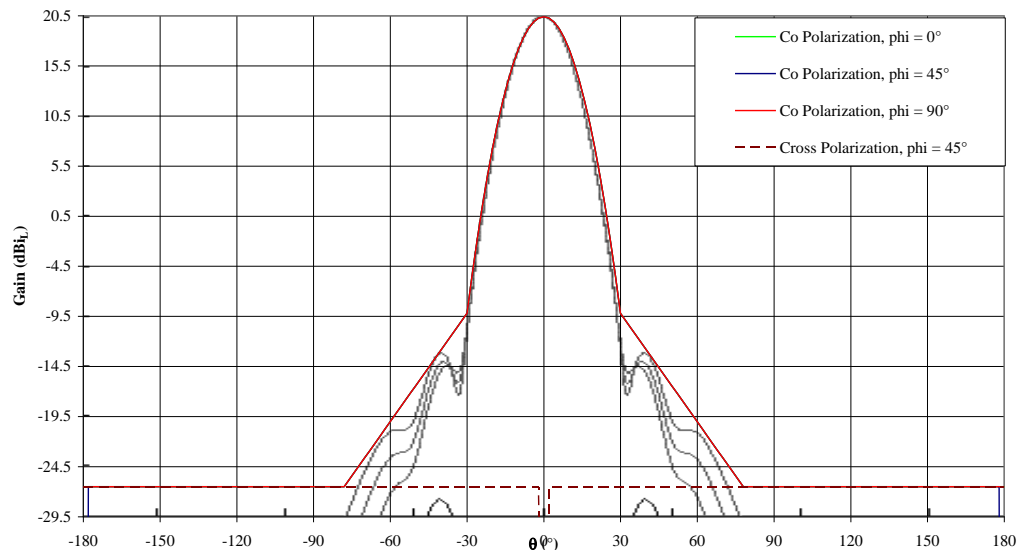

Ku-Band Feed gain (measured & envelop)

Overview of the Method

This software is based on the Unified Geometrical Theory of Diffraction (UTD). The GTD is a generalization of the classical geometrical optics theory which enables to convey the phenomena of diffraction by introducing a new kind of rays, the « diffracted » rays. The theoretical aspects of GTD are explained to a great extent in the “Theoretical Background” chapter. The ray tracing from the diffracting elements is performed by applying Keller’s diffraction laws. The value of the diffracted field is determined in terms of the initial value of the field on the diffracting element by means of the optical principles of phase variation and energy conservation. This value can be obtained by multiplying the incident field by the diffraction coefficient as derived by Kouyoumjian and Pathak in their Unified GTD.

The use of the software consists of three main parts:

- **The path pre-determination** estimate by a forward ray-tracing the potential paths from the source either to the far field sphere (for far field pattern), to receiving antennas (for antenna to antenna coupling) and to target surfaces (for target field calculations).
- **The path correction** solves the exact interaction positions and ray path from the source to their destinations. This part has been optimized to handle single targets (as antennas or not meshed targets) or multiple targets (meshed targets).

- **The E-Field propagation** computes either the field in the chosen directions (far field calculations), or the coupling between antennae (antenna to antenna coupling), or the field on surfaces (near field calculations) using the ray paths.

The GTD Ray-Tracing

The conventional ray tracing used in connection with GTD calculations is based on a backward ray tracing, which is an analytical method by which the possible ray types are checked for existence and when existing the precise ray path to the given far field direction is determined. The main problem of this technique is to have automatically determined all possible ray types without a need for checking an immense number of unrealistic ray types. However, the ray-tracing used in this software is based on a forward ray-tracing where a large number of uniformly distributed rays are emitted from the antenna, which is modeled as a point source. The rays may undergo single or multiple interactions (reflection, diffraction) before they finally reach their final destination. In this version of the software a maximum of 2 interactions can be processed.

The handling of diffraction requires a geometrical analysis to determine when diffraction occurs, and on which edge. Since rays have nearly no chance to hit directly an edge, the software constructs diffracted rays, starting from reflected rays. So each time a surface is hit, starting from the impact point on the surface, the software searches edges. Diffraction may be possible if the impact point is near one or several edges.

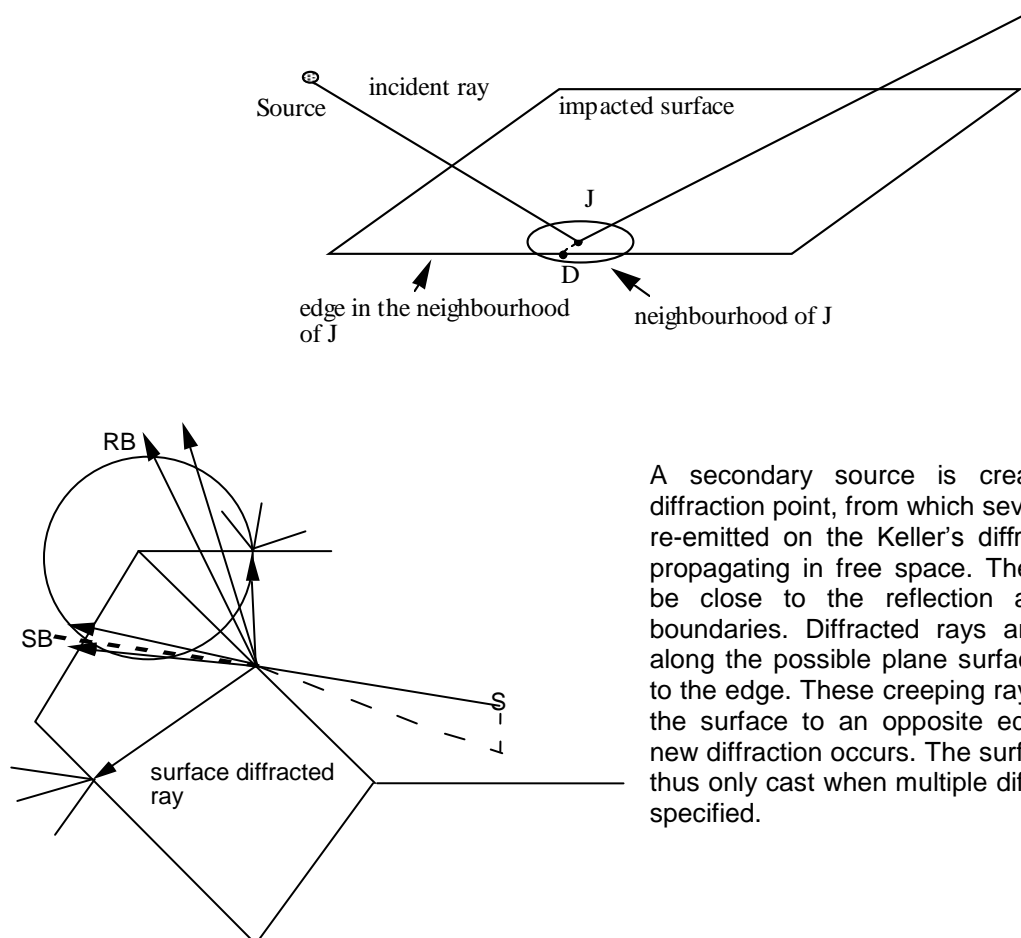

A secondary source is created at the diffraction point, from which several rays are re-emitted on the Keller's diffraction cone, propagating in free space. These rays will be close to the reflection and shadow boundaries. Diffracted rays are also cast along the possible plane surfaces common to the edge. These creeping rays, will follow the surface to an opposite edge where a new diffraction occurs. The surface rays are thus only cast when multiple diffractions are specified.

➤ **Planarity tolerance for Automatic diffraction:**

When the *Edge Diffraction* is set to *Automatic*, the edge will not diffract where it has a contact defining a flat angle. The planarity tolerance may be used in that case in order to set the angular tolerance on flat contacts.

➤ **Edge Diffraction:**

This property sets if an edge is diffracting (*Diffract*) or not (*None*). It is also possible to leave this option to *Automatic* that de-activates diffraction if the edge defines a flat angle between 2 shapes or if the shape has an *Absorbent* or *Transparent* surface property.

Edges are numbered 1 to 4. In case it is required to set edge diffraction other than *Automatic*, the correspondence between edge numbers and surface definitions is given in the following table.



GTD Properties

The properties set at an object level are automatically propagated to all its sub-tree unless "*Local configuration*" is set bellow. It is also possible to overload inherited properties. In that case the overloaded properties will be propagated bellow the object on which the overload has been made.

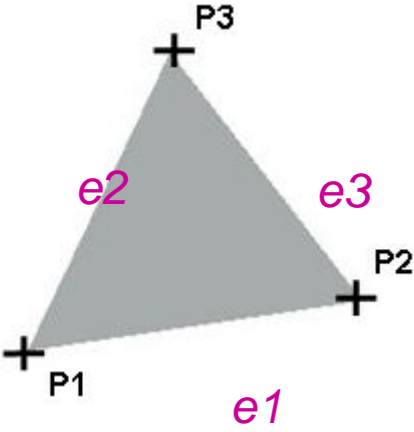
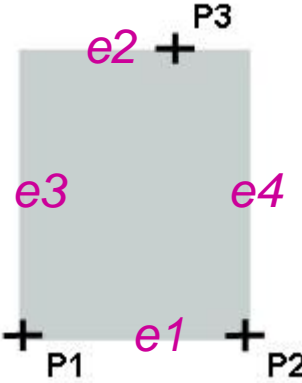
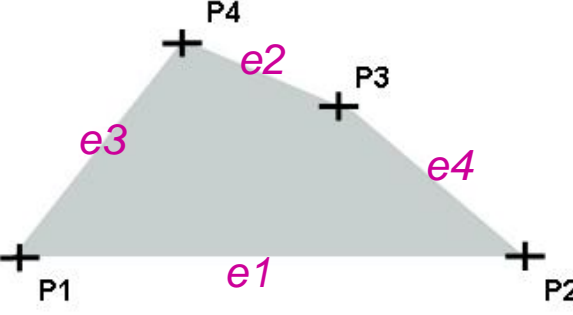
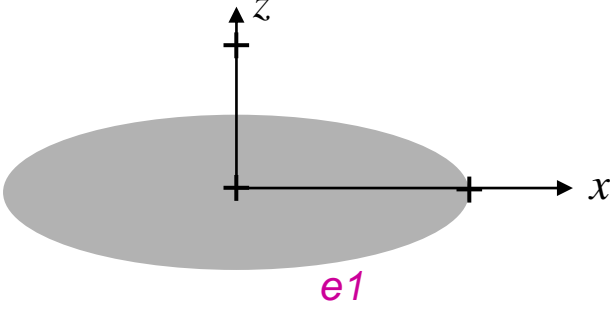
<p>Triangle</p>	 <p>A gray-shaded triangle with three nodes marked with a cross: P1 at the bottom-left, P2 at the bottom-right, and P3 at the top. The edges are labeled in pink: e1 is the bottom edge, e2 is the left edge, and e3 is the right edge.</p>
<p>Rectangle</p>	 <p>A gray-shaded rectangle with four nodes marked with a cross: P1 at the bottom-left, P2 at the bottom-right, and P3 at the top-right. The edges are labeled in pink: e1 is the bottom edge, e2 is the top edge, e3 is the left edge, and e4 is the right edge.</p>
<p>Quadrangle</p>	 <p>A gray-shaded quadrangle with four nodes marked with a cross: P1 at the bottom-left, P2 at the bottom-right, P3 at the top-right, and P4 at the top-left. The edges are labeled in pink: e1 is the bottom edge, e2 is the top edge, e3 is the left edge, and e4 is the right edge.</p>
<p>Full Disc</p>	 <p>A gray-shaded elliptical disc centered at the origin of a coordinate system. The vertical axis is labeled 'z' and the horizontal axis is labeled 'x'. The edge of the disc is labeled in pink as e1.</p>

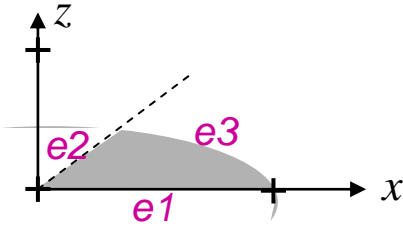
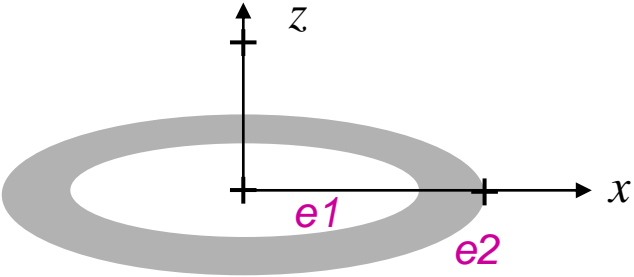
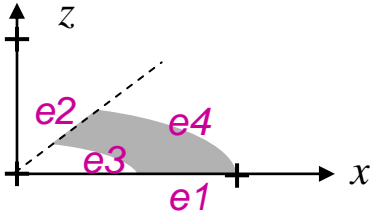
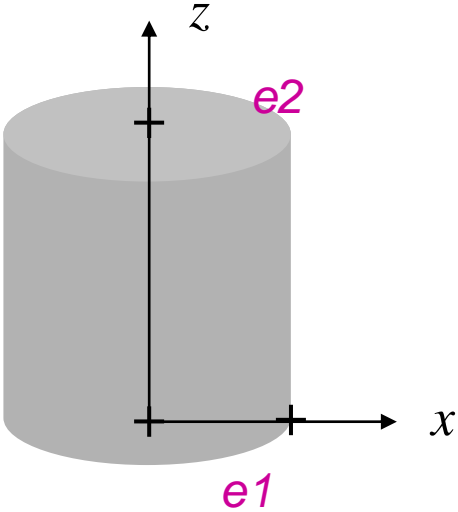
<p>Truncated Disc 1 And similar truncated Cone / Sphere <i>(similar to triangle)</i></p>	
<p>Truncated Disc 2 <i>(full ring)</i></p>	
<p>Truncated Disc 3 <i>(similar to quadrangle)</i></p>	
<p>Cylinder And similar Truncated Cone / Sphere / Parabola</p>	

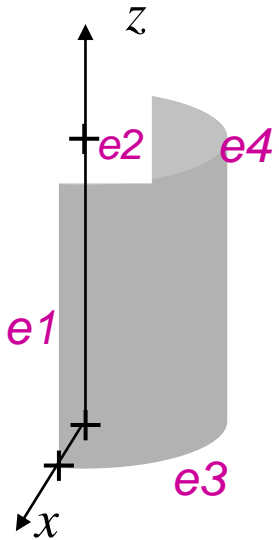
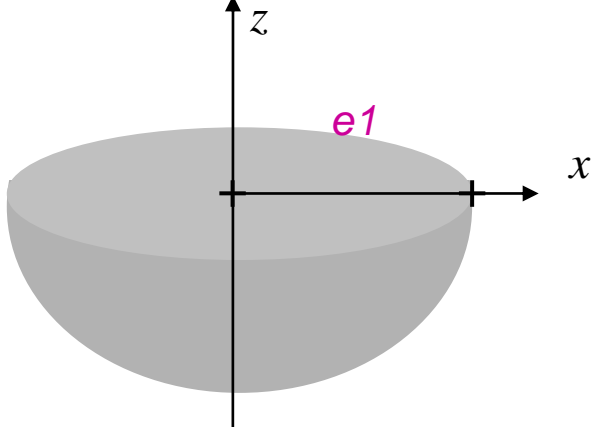
<p>Truncated Cylinder And similar Truncated Cone / Sphere / Parabola <i>(similar to rectangle)</i></p>	
<p>Parabola / Antenna And similar Cone / Truncated Sphere</p>	

Edge / Surface correspondence table

4.2 The GTD Meshing

Geometric Meshing

By default the geometry is meshed 1x1 leading to one mesh per shape is numbered by hundreds. This default structure is suitable for the **GTD** computation and the mesh shall not be extended except for target surfaces. The numbering may be left with default values.

The surface that will be defined as a target may be meshed in order to get several results, leading to a mapping E-Field into the surface.

GTD Specific Items

If antennas and targets geometries have been defined in the model they are not yet referenced as being such elements (they are only geometrical elements of the model). Indeed it is required to indicate that the geometrical shape represents a specific element of the computation. This operation is performed using the “*Specific Items*” of the meshing structure.

Specific items may include properties and links to the geometry.

4.3 Antennas Definition

The **GTD** antennas may be of the following kind:

- **Cardioid**
- **Standard feed**
- **Measured**
- **Envelop**
- **Spherical wave expansion**

For each antenna, it is required to link the definition to a cone shape that gives the origin of the feed (corner of the cone) and its orientation: the Z axis of the cone, in its opening direction, gives the main orientation of the feed (theta=0°); the X axis gives the cut reference (phi=0°).

The link is done by selecting the shape from the “General” Tab of the Antenna Specific Item.

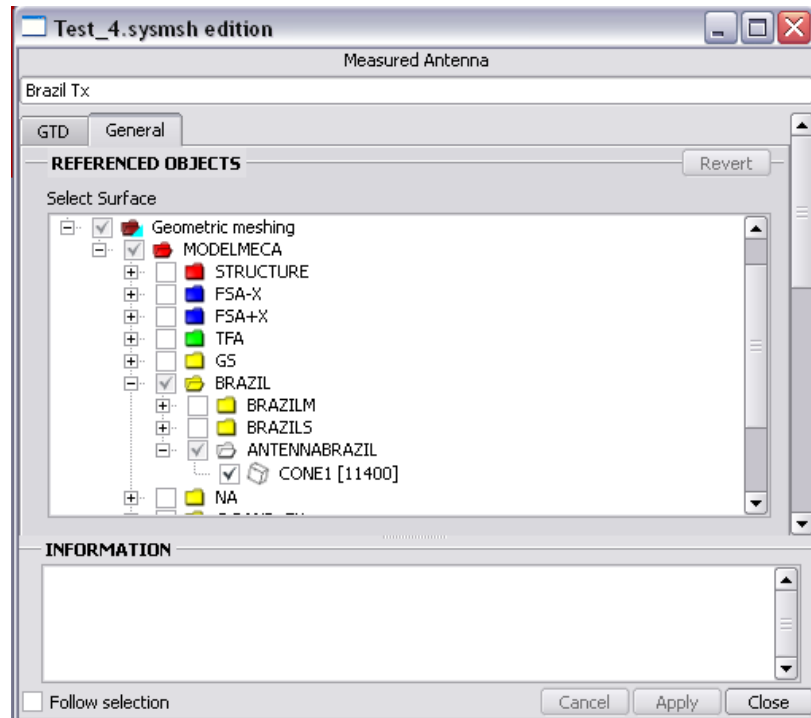

Antenna Geometrical Reference

Common Properties

Bellow the **GTD** tab of the Antenna Specific Item, the properties of the antenna shall be set. The first category of properties, called “Antenna” contains general properties common to all the antenna feeds.

The common properties are:

- **Frequency:** defines the frequency of the antenna in GHz.
- **Power:** defines the power emitted by the antenna in dBW. This property is only used to compute the E-Field on targets.

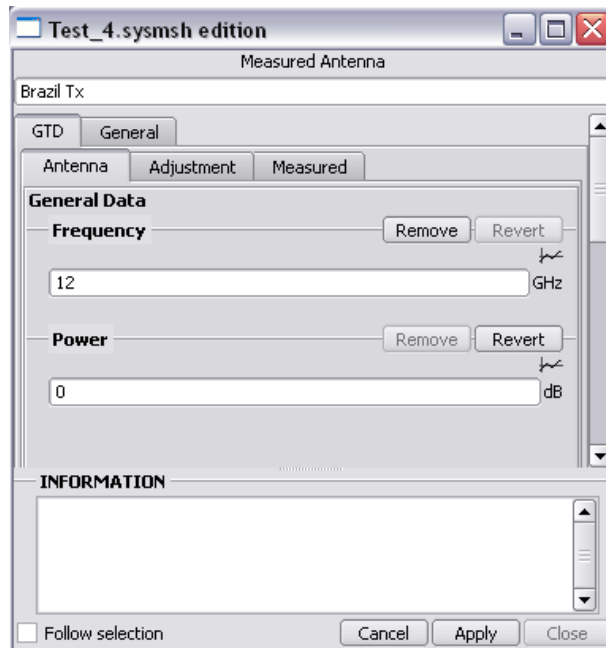

Antenna Common Properties

Cardioid Shaped

This model approximates a cardioid shaped, circularly polarised satellite telemetry and telecommand antenna pattern. The sense of the polarisation and the relative level of the back radiation in the opposite polarisation may be specified. The halfpower beamwidth is specified by the user for each sense of polarisation assuming a pattern function of the shape:

$$f(\theta) = K \left[\frac{1 + \cos(\theta)}{2} \right]^n$$

where the power n depends upon the beamwidth specified. The constant K normalises the pattern to isotropic level.

The following figure illustrates the pattern. The half power half beam widths for co- and cross-polar main lobes are illustrated (it is the full beam width which shall be specified) and the level of the cross polar back lobe is given by the front-to-back ratio.

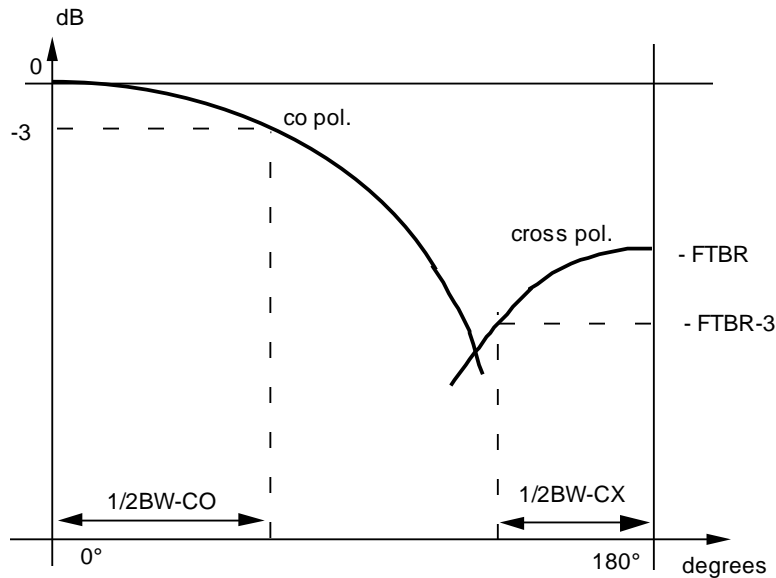

Cardioid shaped antenna pattern

The half power co-polar beamwidth is BW-CO and the half power beamwidth of the backward radiating cross-polar lobe is BW-CX. The front-to-back ratio of the pattern is FTBR. FTBR is usually positive.

The Cardioid properties are:

- **Half power beamwidth of co-polar pattern:** in degrees.
- **Half power beamwidth of cross-polar pattern:** in degrees.
- **Front to back ratio:** in dB.
- **Polarization type:** defines the co-polar polarization type that may be either RHCP (right hand circular polarized) or LHCP (left hand circular polarized), in dB.

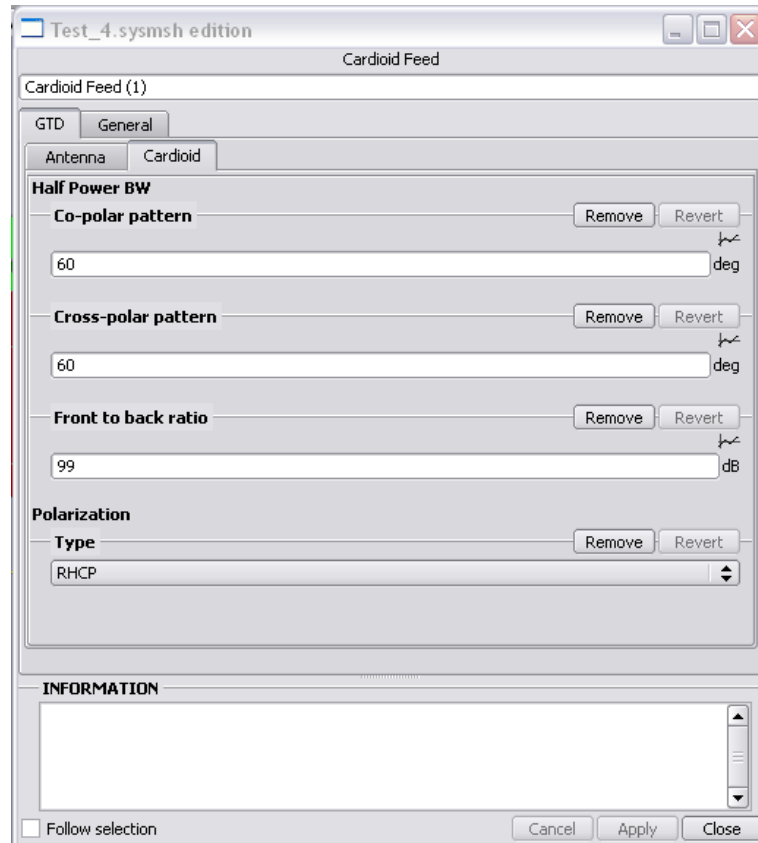

Cardioid Properties

Standard Feed

This antenna model generates a pattern with user-specified tapers in the xz- and yz- planes. The amplitude function referred to isotropic level in the xz-plane is $E_{zx}(\theta)$

$$E_{zx}(\theta) = A_0 \cdot 10^{(A_x/20) \cdot (\theta/\theta_0)^2}$$

where A_x is the amplitude level in dB at $\theta = \theta_0$ relative to maximum level A_0 . A similar pattern $E_{zy}(\theta)$ defined by the relative amplitude level A_y at $\theta = \theta_0$ is assumed for the yz-plane (see next figure). A_0 is a gain normalisation constant found by a pattern integration. In the normal case where both A_x and A_y are negative, the integration is carried out down to 40 dB below the maximum level. If either A_x or A_y is positive or zero, the integration is carried out to θ_0 . It is possible also to generate a feed with constant amplitude or one can specify an inverse taper in order to simulate an approximately constant amplitude of a reflector aperture illumination. The user specifies the polarisation which can be linear along the x- or the y-axis, or right or left hand circular.

A cross polar level may be specified. The cross-polarised pattern will be identical to the co-polar pattern with a relative amplitude and phase as specified by the user.

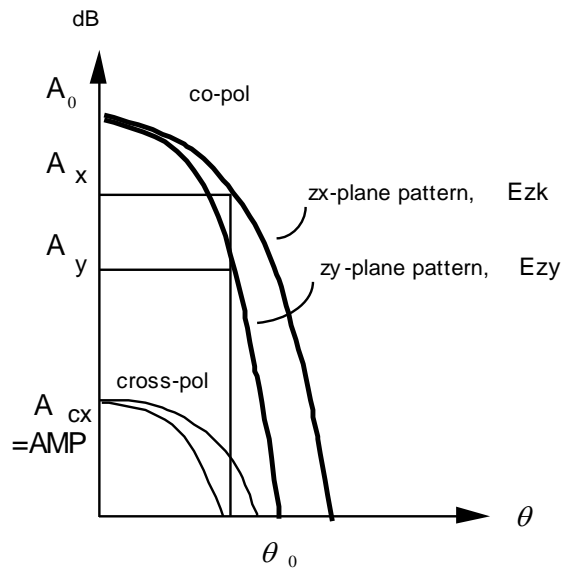

Standard feed antenna pattern

The Standard Feed properties are:

- **Polarization type:** defines the co-polar polarization which may be LIN-X (linear polarization along x for $\theta=0^\circ$), LIN-Y (linear polarization along y for $\theta=0^\circ$), RHCP (right hand circular polarization) or LHCP (left hand circular polarization).
- **Relative level at Theta-0:**
 - **Theta-0:** value of the angle in degree
 - **In ZX:** relative level in dB at $\theta=0$ in zx plane ($\phi=0^\circ$)
 - **In ZY:** relative level in dB at $\theta=0$ in zy plane ($\phi=90^\circ$)
- **Relative cross polarization:**
 - **Amplitude:** relative amplitude of cross-polarization in dB
 - **Phase:** relative phase of cross-polarization in degree

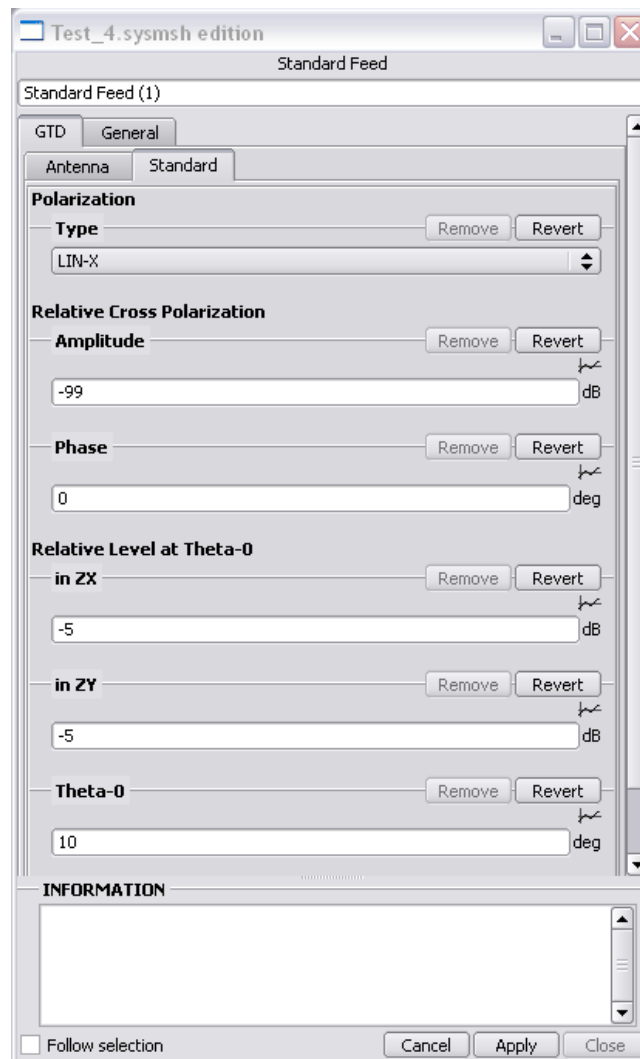

Standard Feed Properties

Measured Pattern

By this antenna specification the horn is described by pattern data in polar θ -cuts, for instance from a measurement or from a horn aperture or array element radiator analysis program. The same data must be input either as full cuts, $-\theta_{\max} \leq \theta \leq \theta_{\max}$, or as half cuts, $0 \leq \theta \leq \theta_{\max}$. The time factor can be either $\exp(-i.\omega.t)$ or $\exp(+j.\omega.t)$. No restrictions are imposed on the number of pattern cuts on the spacing between pattern cuts apart from the number of half cuts must be even and not less than four. However, in each cut data must be provided in equispaced θ -points. When the program execution is initiated, the input data are converted to azimuthal modes, i.e. the pattern is expressed as a summation of modes, $A(\theta)\exp(-jm\phi)$. For each θ value, the modes are calculated by a Fourier transformation. Later, the program calculates the field in the specified direction by interpolation.

The number of modes is automatically set to $N_{full}-1$, where N_{full} is the number of full polar cuts (or the half of the number of half cuts).

It is possible to adjust the phase reference point as the phase reference point in the measured input data may be different from the optimum phase centre position.

The input data can be normalised to dBi and scaled in phase, or, alternatively, scaled by a complex factor.

If the pattern cuts on input have different field values for $\theta = 0$ (i.e. the cuts are inconsistent at the pole in amplitude, phase or polarisation) it is possible to impose an equalisation of the values in this direction (cut adjustment). The equalisation adjusts each cut to have identical complex amplitude for the principal polarisation at $\theta = 0$. The cross polarisation in this main direction is assumed low and not used for the adjustment.

The program assumes that a typical lobe in the pattern has a half power beam of $60^\circ/N_{full}$ and suggests this as a default value. If this value is far from correct a better may be specified.

The pattern input routine is designed to read complex pattern field data represented by real and imaginary values. The format of this file is the GRASP format.

The Measured properties are split into 2 main categories: Adjustment and Measured.

The Measured properties are:

- **File:** name of the file where the measured pattern is stored.
- **Half power beamwidth:** half power half beamwidth of typical lobes of the pattern, in degree.
- **Phase notation:** i-notation or j-notation indicates wheter the measured phase increase (i-notation) or decrease (j-notation) when the measuring probe moves away from the measured antenna. The i-notation corresponds to a time factor $\exp(-i.\omega.t)$, j-notation corresponds to a time factor $\exp(j.\omega t)$. Most measurements equipment output results are in j-notation.

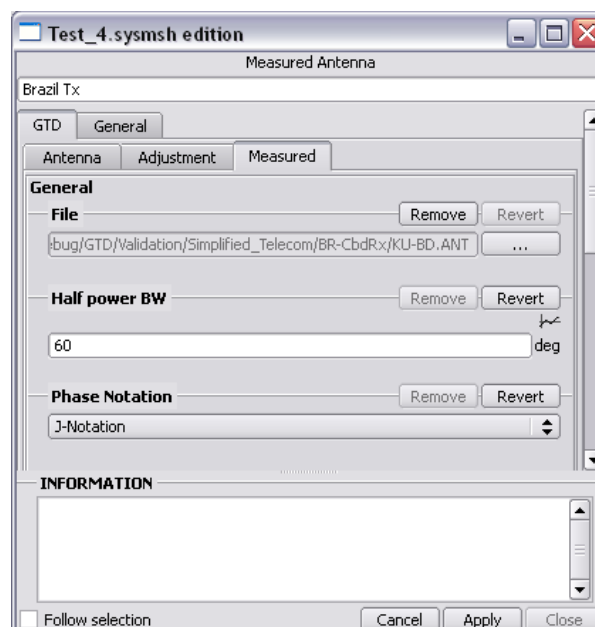

Measured Antenna Properties

The Adjustment Measured properties are :

- **Cut adjustment:** pattern cuts may be adjusted in amplitude to have identical principal polarization component at $\theta=0^\circ$. The polarization of the input field is used. This option is by default to “Yes”.
- **Phase adjustment:** the phase reference point is adjusted to a position (x,y,z) in the measurement coordinate system (meter).
- **Scaling:** The measured pattern can be scaled by a complex factor of amplitude in dB and a factor of phase in degree.

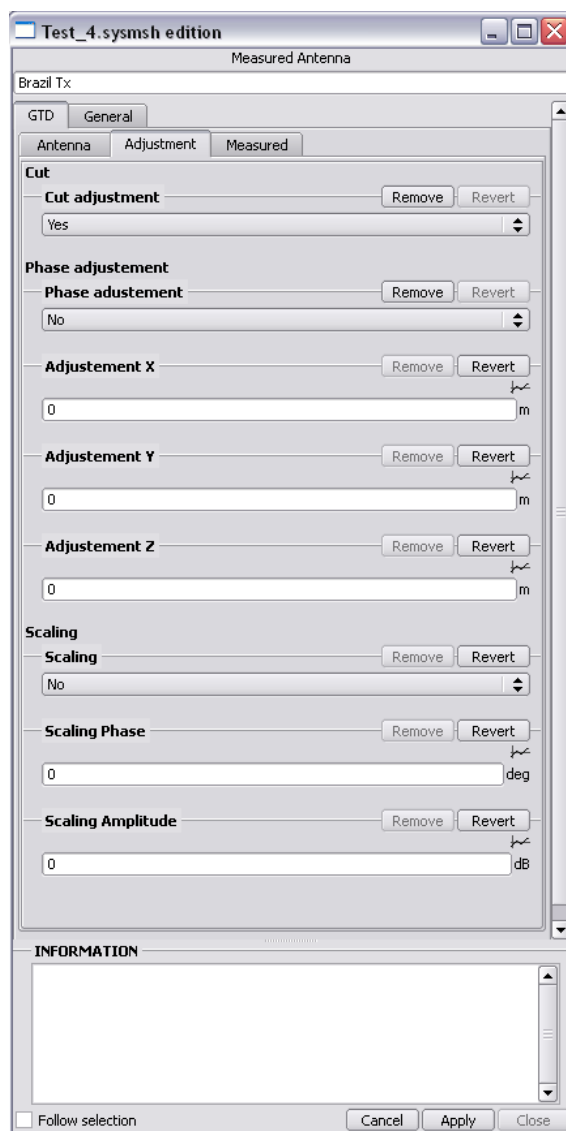

Measured Adjustment Properties

Envelop Pattern

The envelop Pattern is useful to define a profile of antenna pattern by its envelop.

Patterns are defined with their Co polarization and cross polarization.

Polarizations are either linear or circular.

Co Polarization is defined in three parts: Gaussian, Linear and Flat from 0 to 180° (the pattern is symmetric).

The gains and angles to be defined are:

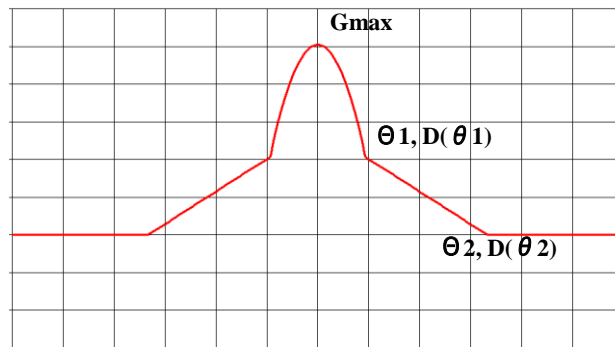

Cross Polarization is defined in three parts: flat, linear and flat from 0 to 180° (the pattern is symmetric).

The gains and angles to be defined are:

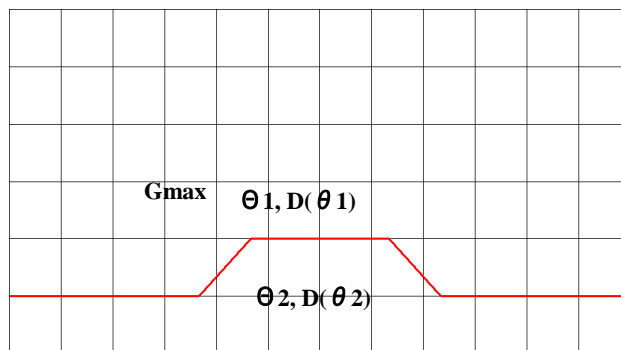

Antenna	Envelop
Co-polar Absolute Level	
Dmax=D(theta=0)	Remove Revert
20	dB
Theta 1	Remove Revert
20	deg
D(Theta 1)	Remove Revert
5	dB
Theta 2	Remove Revert
80	deg
D(Theta 2)	Remove Revert
-20	dB
Cross-polar Absolute Level	
Dmax=D(theta=0)	Remove Revert
-16	dB
Theta 1	Remove Revert
25	deg
D(Theta 1)	Remove Revert
-16	dB
Theta 2	Remove Revert
40	deg
D(Theta 2)	Remove Revert
-24	dB
Polarization	
Type	Remove Revert
LIN-X	

Envelop Properties

Spherical Wave Expansion

Spherical Wave Expansion is a format (SWE) describing the pattern of the antenna which is widely used as input or output of RF simulation tools. The **GTD** software is compatible with this self content definition for which no other option than the file reference is required.

4.4 Targets Definition

A target is a surface on which the incoming E-Field from an antenna and its power decoupling are computed.

A target shall be linked to a rectangle or a full disc for which its surface properties (conductive, transparent or absorbent) will still be taken into account for the ray propagation.

If a target is meshed, then the E-Field and Power decoupling will be computed for each individual mesh, leading to the possibility of mapping those results onto the surface and of searching extreme values.

Uniform Target

A uniform target may be used to get results on a surface considering the sum of all contributions regardless to their direction. A uniform target behaves like an omnidirectional antenna.

The E-Field on the surface is computed with the following formulae:

$$E = \frac{4\pi}{\lambda} \sqrt{30.P}$$

Where the received power P is computed from the power emitted by the antenna source $P_{antenna}$ and the decoupling value obtained on the target D :

$$P = \frac{P_{antenna}}{D}$$

Aperture Target

A target aperture may be used to represent a rectangular or circular aperture. Indeed the E-Field and Power decoupling take into account its radiation pattern. The figure here below shows the polar angle convention.

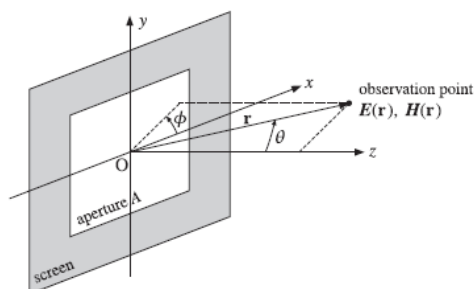

Radiation fields from an aperture

The decoupling computed from the antenna to the target is then corrected on each ray by the following gain normalization coefficient:

$$D = \frac{|E(\theta, \phi)|}{|E|_{\max}} = \sqrt{g(\theta, \phi)} = \left(\frac{1 + \cos \theta}{2} \right) |f(\theta, \phi)|$$

Where the function $f(\theta, \phi)$ depends on the aperture geometry.

For a circular aperture of radius a , the cylindrical symmetry implies that the function $f(\theta, \phi)$ is independent of ϕ . Then:

$$f(\theta) = 2 \frac{J_1(ka \sin \theta)}{ka \sin \theta} = 2 \frac{J_1(2\pi u)}{2\pi u}$$

Where $J_1(x)$ is the Bessel function and $u = \frac{1}{2\pi} ka \sin \theta = \frac{a}{\lambda} \sin \theta$.

The figure here below presents an example of the radiation pattern of a circular aperture with $a = 3\lambda$:

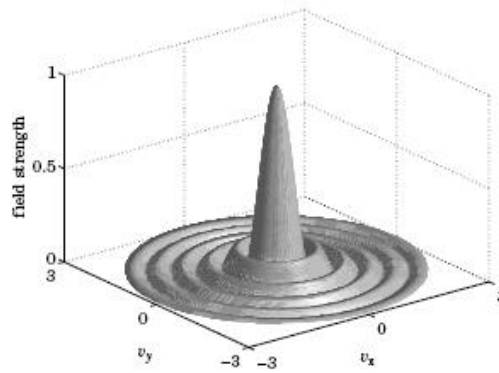

Radiation pattern of circular aperture

For a rectangular aperture of sides a and b , the function $f(\theta, \phi)$ is equal to:

$$f(\theta, \phi) = \frac{\sin(ka/2)}{ka/2} \frac{\sin(kb/2)}{kb/2} = \frac{\sin(\pi v_x)}{\pi v_x} \frac{\sin(\pi v_y)}{\pi v_y}$$

Where

$$v_x = \frac{1}{2\pi} ka \sin \theta \cos \phi = \frac{a}{\lambda} \sin \theta \cos \phi$$

$$v_y = \frac{1}{2\pi} kb \sin \theta \sin \phi = \frac{b}{\lambda} \sin \theta \sin \phi$$

The figure here below presents an example of the radiation pattern of a rectangular aperture with $a = 8.\lambda$ and $b = 4.\lambda$:

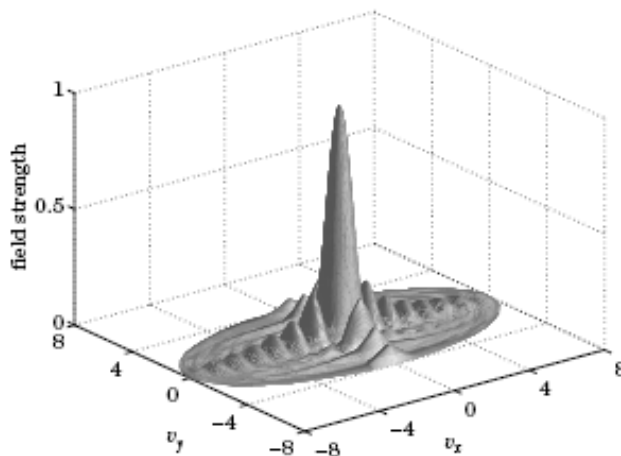

Radiation pattern of a rectangular aperture

The E-Field is then computed as for a uniform target but using the computed decoupling which has taken into accounts the radiation pattern of the aperture.

5 GTD Analysis

5.1 Process Overview

Once the input model has been correctly set with its properties and its meshing, the computation process can be set and executed from the *Processing* tab of **SYSTEMA**.

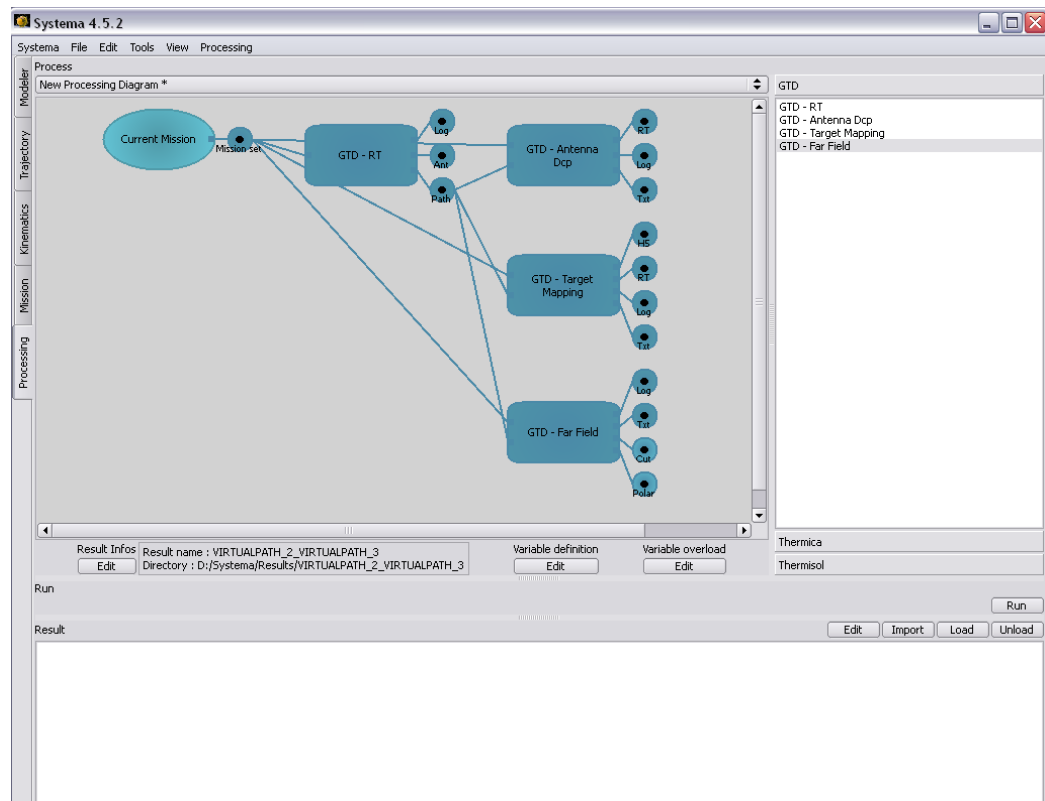

GTD Process Diagram

The GTD Ray-Tracing module pre-determines the possible path to the far sphere directions, antennas and targets. The three other modules (Antenna Dcp / Target Mapping / Far Field) are dedicated to the correction and the E field propagation to the computations points or directions.

A process can be added to the process diagram by double clicking on it from the list of processes on the right side of the windows or by a drag-and-drop from this list to the diagram. The input called "Current Mission" will be automatically added if it is not already set in the diagram.

The ellipsoid called "Current Mission" is the input of the computation. This input will be pre-processed for the computation module, creating an intermediate file called *Mission Set* (sysset file).

The current mission can be edited to select the kind and path of the input. In the case of a **GTD** computation, the input may be a single meshing (rather than a mission which may contain also trajectory and kinematics elements not handled by the GTD program).

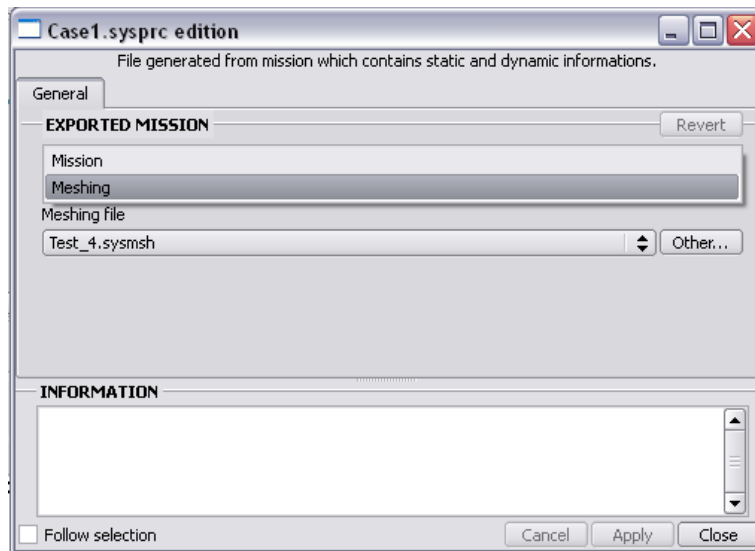

Input setting of the GTD process

By default, all created files will be named using the input process name. The results will be stored in a folder named from the input and process names. This folder is by default located in the input file directory. It is possible to modify those default options from the *Result Infos* edition button.

The GTD – RT process produces a file (called *Path*) which is required for any other GTD module. Indeed, it has to be connected has an input to the modules requiring this input (or a previously computed *Path* file may be selected from the hard-drive).

The modules may be also edited in order to set the properties of the computation. Those properties are split into module dependent parameters (specific to each module instance of the process diagram) and *Common* properties which are shared by all GTD modules.

In the *Common* parameters, the user can set the Beam maximum diameter, i.e. all cylinders with a diameter bellow the specified value will be considered as a beam.

5.2 GTD Ray-Tracing Module

The Ray-Tracing process pre-determines the possible path from a source to all destinations (antennas, targets and far sphere) using a forward ray-tracing technic. This module produces a *Pah* file (binary) that shall then be used by the other modules.

The *Emitting Antenna* parameters allow selecting the source. To select a specific antenna, its number has to be given as it appears in the antennas list of the meshing between brackets.

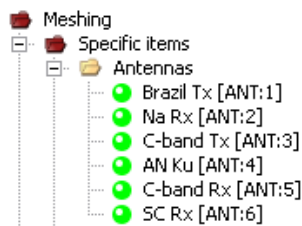

Antennas list From the Meshing structure

The *Ray-Tracing Parameters* contains all the options required for the ray-tracing and path determination. The ray-tracing being based on a random ray direction approach, it is possible to select a random seed that will affect the random series used and consequently the ray emitted from the source. Modifying this value may be useful if the results of a previous computation may be incomplete because of an insufficient number of rays used. In that case, re-running the process with a different random seed will lead to a new computation with different rays.

The numbers of rays used are by default 2.000.000 from the antenna (primary source) and 1.800 from each diffraction point (secondary source). If the model has many diffractive edges, this may result of a total number of rays up to 6.480 billion (but also many possible paths between sources and destinations that need to be tested). The number of rays used shall then be a good compromise between good accuracy (all path are determined) and execution time. The default values are set to provide a good level of accuracy for an execution time not generally exceeding 10 minutes.

The total number of interactions and especially the number of diffractions for each path may also be modified. The maximum, and default value, of interactions is 2 including 2 possible diffractions.

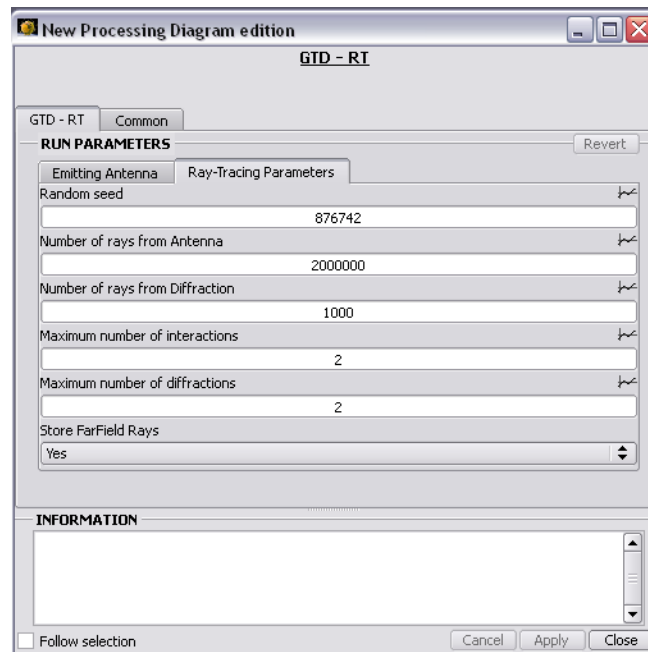

GTD Ray-Tracing Parameters

A final option called "Store FarField Rays" may be set to the value "No" in case the *Path* file will not be used for any Far Field Pattern computation. In that case, the CPU time is decreased since much less pre-defined path are to be managed.

GTD-RT Outputs

There are three output files from the GTD computation:

- **Log file:** execution summary of the process.
- **Antennas & Targets diagram:** curves of input antenna patterns and target radiation pattern – PS format (post-script)*.
- **Path:** Contains all pre-determined path details for further path correction.

*Note: If a ps2pdf executable is defined in environment variable GTD_PS2PDF, GTD will automatically convert the generated PS files to PDF.

5.3 GTD Antenna Decoupling Module

The Antenna Decoupling module computes the decoupling between two antennas (or eventually a self-decoupling).

The module options are mainly the selection of the receiving antenna, specified as for the emitting antenna – i.e. using the antenna's index visible on the meshing – but with the possibility to select all antennas (by setting a value of 0) allowing to perform all decoupling computations at once.

The second option of this module is the *Ray output Filter*, set to -30 dB by default which enables to remove from the output all rays having a contribution less than 30 dB compared to the maximum one.

GTD- Antenna Dcp Outputs

There are three output files from the GTD computation:

- **RT results:** ray-tracing paths and properties for displaying rays in the SYSTEMA modeler – HDF5 format.
- **Log file:** execution summary and extended results dedicated to results checking.
- **Txt results:** textual results presenting all rays contributions sorted by decoupling decreasing order.

The Decoupling results are given by summation of all rays contributors. The complex, amplitude and root square sums are all specified.

The complex sum is the smallest one, the phases of each contributors being different. This is also the closest result to the physics but since a small variation or approximation on the geometry may lead to a greater variation of the total decoupling value, a worst case value is generally preferred.

The amplitude sum is the greatest one, all amplitude being summed independently of their phase. This value is worst case but is generally too over-estimated.

The root square sum corresponds to a power sum of all contributors. Its value is in between the complex and amplitude sum and is generally kept as the final results of the antenna's decoupling.

Antenna 1 :

-> To Antenna 2

Antenna 1 to Antenna 2 (220 rays)									
Ray	Type	Complex decoupling		Decoupling					

1	D	-6.0250e-06	-3.3699e-05	-89.31	D (surf 1800 - edge 1)			(-62.48, -55.48, -57.10)	(-78.34
2	RD	1.4055e-06	2.5686e-05	-91.79	R (surf 2300) / D (surf 1800 - edge 1)			(-63.03, -53.00, -57.29)	(-65.41
3	DR	-1.6831e-05	-1.3058e-05	-93.43	D (surf 1800 - edge 1) / R (surf 2300)			(-62.28, -55.16, -56.93)	(-72.38
4	DR	1.0255e-05	1.6827e-05	-94.11	D (surf 1800 - edge 2) / R (surf 2300)			(-62.65, -55.90, -57.09)	(-73.73
5	DR	6.8856e-06	1.5529e-05	-95.40	D (surf 12400 - edge 1) / R (surf 1400)			(-69.39, -73.96, -68.09)	(-88.71
6	RD	-1.4305e-05	6.8931e-06	-95.98	R (surf 2300) / D (surf 11300 - edge 1)			(-62.85, -47.78, -53.77)	(-67.52
7	DR	-1.0526e-05	1.7742e-06	-99.43	D (surf 1900 - edge 2) / R (surf 2300)			(-63.08, -57.12, -57.01)	(-80.29
8	D	-2.0693e-06	8.5764e-06	-101.09	D (surf 11600 - edge 1)			(-63.20, -60.51, -53.35)	(-91.68
9	D	6.6980e-06	-4.5113e-06	-101.86	D (surf 11300 - edge 1)			(-58.98, -54.69, -47.96)	(-89.86
10	D	-5.1555e-06	3.3808e-06	-104.20	D (surf 2100 - edge 4)			(-66.88, -61.14, -62.18)	(-93.23
11	DD	-1.5575e-07	5.2253e-06	-105.63	D (surf 11300 - edge 1) / D (surf 11600 - edge 1)			(-59.03, -55.92, -47.90)	(-78.58
12	R	7.9153e-07	-4.8557e-06	-106.16	R (surf 700)			(-79.39, -74.31, -76.78)	(-81.29
13	DD	4.6807e-06	-1.0105e-06	-106.40	D (surf 2100 - edge 3) / D (surf 11600 - edge 1)			(-63.09, -56.44, -57.63)	(-76.95
14	Dir	-1.8266e-06	4.3868e-06	-106.46				(-79.28, -74.73, -74.72)	
15	DR	9.9391e-07	4.4142e-06	-106.89	D (surf 500 - edge 1) / R (surf 700)			(-70.62, -79.42, -58.80)	(-80.36
16	DR	-5.8208e-07	-4.4286e-06	-107.00	D (surf 2300 - edge 2) / R (surf 1800)			(-61.19, -48.53, -55.23)	(-83.66
17	R	-3.5748e-06	2.5177e-06	-107.19	R (surf 2300)			(-75.10, -76.79, -64.44)	(-80.90
...									
...									
...									
218	DD	7.9063e-12	-6.9260e-12	-219.57	D (surf 1500 - edge 4) / D (surf 11200 - edge 1)			(-79.97, -72.63, -73.44)	(-122.50

Total Decoupling :

Complex sum	4.1767e-05	or	-87.58 dB	(Total)
Amplitude sum	2.4797e-04	or	-72.11 dB	(Worst case)
RSS sum	6.1267e-05	or	-84.26 dB	(Power sum)

Textual GTD Results

5.4 GTD Target Module

The Target module is very similar to the decoupling value, considering each target mesh as an antenna (with either a uniform pattern – worst case – or considering the aperture’s pattern).

The target module options are also identical to the antenna’s decoupling module, i.e. the selection of the receiving target (0 for all or using the target index from the meshing tree list) and the output ray filter.

GTD- Target Mapping Outputs

There are four output files from the GTD computation:

- **H5 results:** contains the results on the target mesh for being mapped and displayed onto the geometry – HDF5 format.
- **RT results:** ray-tracing paths and properties for displaying rays in the SYSTEMA modeler – HDF5 format.
- **Log file:** execution summary and extended results dedicated to results checking.
- **Txt results:** textual results presenting all rays contributions sorted by decoupling decreasing order.

For sub-meshed target minimum, maximum and average values of power decoupling:

```

|*****|
|*                TARGET 2 Decoupling                *|
|*****|
|*                Min                Max                Ave                *|
|* Coupling :                                         *|
|* - Complex sum   5.844e-006 (-104.67 dB)  5.898e-005 ( -84.59 dB)  2.253e-005 ( -92.95 dB) *|
|* - Amplitude sum 1.848e-005 ( -94.67 dB)  6.805e-005 ( -83.34 dB)  2.938e-005 ( -90.64 dB) *|
|* - RSS sum       1.026e-005 ( -99.78 dB)  3.391e-005 ( -89.39 dB)  1.621e-005 ( -95.81 dB) *|
|*****|
    
```

Target Decoupling Summary

5.5 GTD Far Field Module

The Far Field module computes the pattern of the field seen from a long distance. The results are given in phi and theta cuts, and polar diagrams.

In the *Computation Mode* parameters, it is possible to choose the reference axis which corresponds to the theta reference (0°). A local frame is then built around this axis, the second angle – phi – being the angle in the direction, depending on the theta reference axis:

+Z reference axis: +X to +Y

+Y reference axis: +Y to +Z

+X reference axis: +Z to +X

-Z reference axis: -X to -Y

-Y reference axis: -Y to -Z

-X reference axis: -Z to -X

The other *Computation Mode* parameters allow choosing the theta amplitude (“Angle Range”), the “discretization Angle” of the output plus an option to filter the double-diffractions from the pre-determined path file.

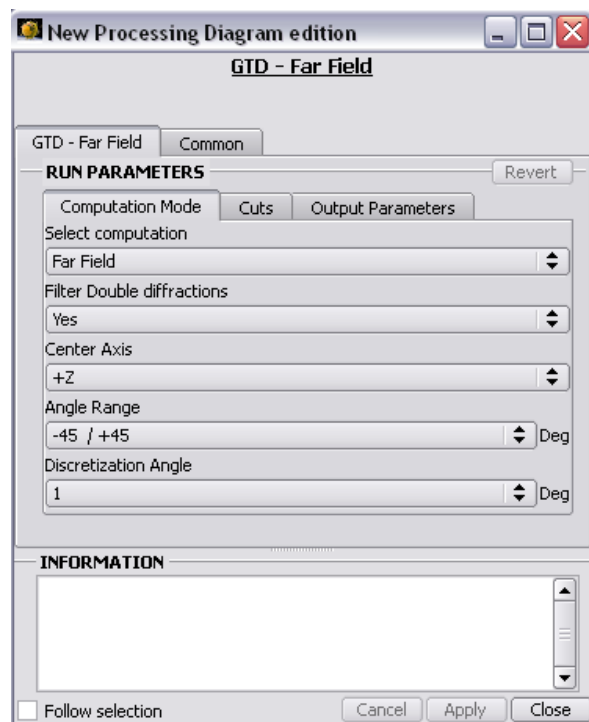

GTD far Field Parameters

A second option category named *Cuts* allows selecting the theta and phi values of the cuts.

Remark: To deactivate the computation of the polar diagram, which requires much more computations and many directions, the output file "Polar" may be directly deactivated from the processing diagram (with a right click on the file icon).

GTD- Far Field Outputs

There are four output files from the GTD computation:

- **Log file:** execution summary and extended results dedicated to results checking.
- **Txt results:** textual results presenting all rays contributions sorted by decoupling decreasing order.
- **Cuts diagram:** curves of output patterns in the selected theta and phi – PS format (post-script)*.
- **Polar diagram:** display of far field pattern in theta-phi polar graphs – PS format (post-script)*.

*Note: If a ps2pdf executable is defined in environment variable GTD_PS2PDF, GTD will automatically convert the generated PS files to PDF.

The cuts diagram is composed of the following graphs:

- Co-Polar Gain in Phi cuts
- Co-Polar Phase in Phi cuts
- Cross-Polar Gain in Theta cuts
- Cross-Polar Phase in Theta cuts
- For each cut:
 - Amplitude of the major contributors to the total field (Co-Polar)
 - Amplitude of the major contributors to the total field (Cross-Polar)

The polar diagram presents the Co-Polar and Cross-Polar amplitudes and phases in four graphs (the amplitude of theta is restricted to 90° on this output).

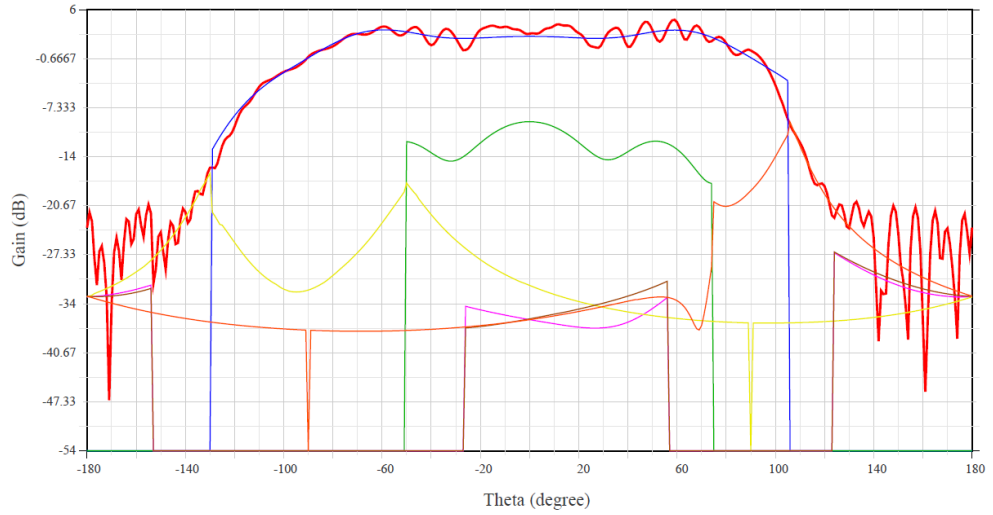

Cross-Polar Phi=0	
Description	Description
<ul style="list-style-type: none"> ■ Total Cross-Polar ◆ Path 1/6 (DIR) ◆ Path 2/6 (R) 100 ◆ Path 3/6 (D) 100 ◆ Path 4/6 (D) 100 	<ul style="list-style-type: none"> ◆ Path 5/6 (D) 100 ◆ Path 6/6 (D) 100

Generated by GTD v4.5, ASTRIUM SAS - 2010 - All rights reserved

page 6

GTD Far Field Cut

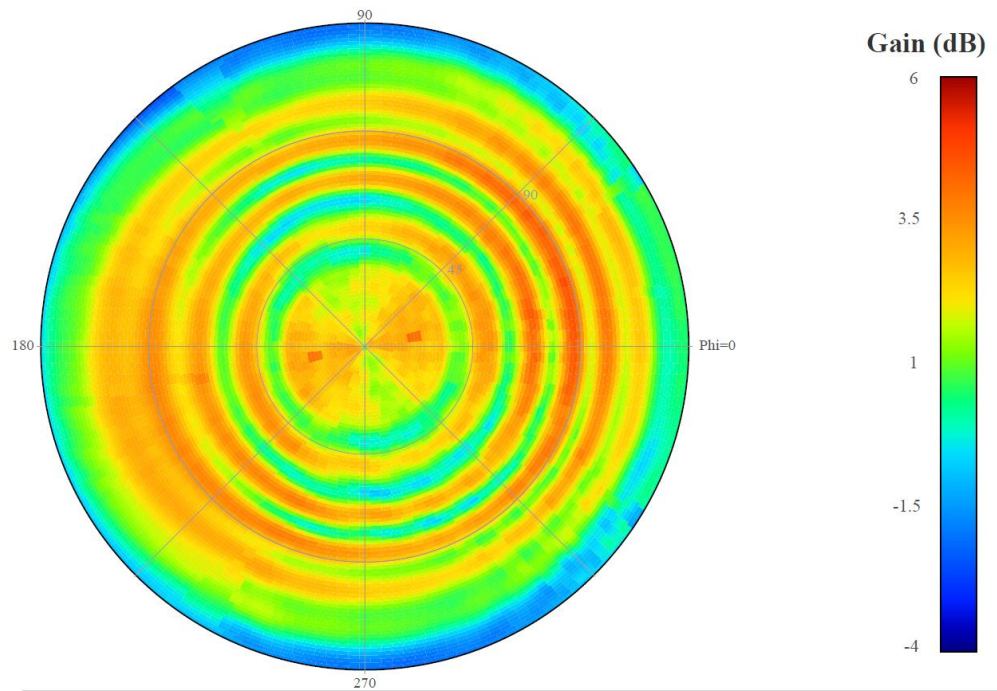

Cross-Polar Amplitude

Generated by GTD v4.5, ASTRIUM SAS - 2010 - All rights reserved

page 3

GTD Far Field Polar Diagram

6 Results Display in SYSTEMA

Applies to Antenna's Decoupling and Target Mapping results (hdf5 output files).

At the end of an execution, the list of outputs appears automatically in the result window of the *Processing* tab. To load or unload results, it is possible to use the corresponding button at the top right of this windows. The set of results are then available through the *sysres* file generated by the execution of the diagram.

Whenever results are loaded (manually or automatically after the execution of a run case), they are available in other tabs in order to graphically post-process the results.

Target Mapping

From a 3D View of the meshing in the *Modeler* tab, it is possible to set the shape appearance to a result. The configure button from the shape appearance selection allows to adjust the scale of the mapping.

Besides the shape appearance, it is possible to select Textual information. Then textual results will appear on a text window for the selected mesh.

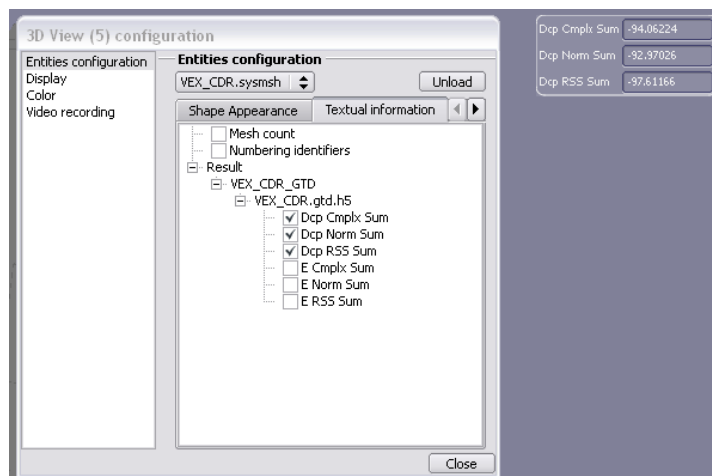

Textual Information

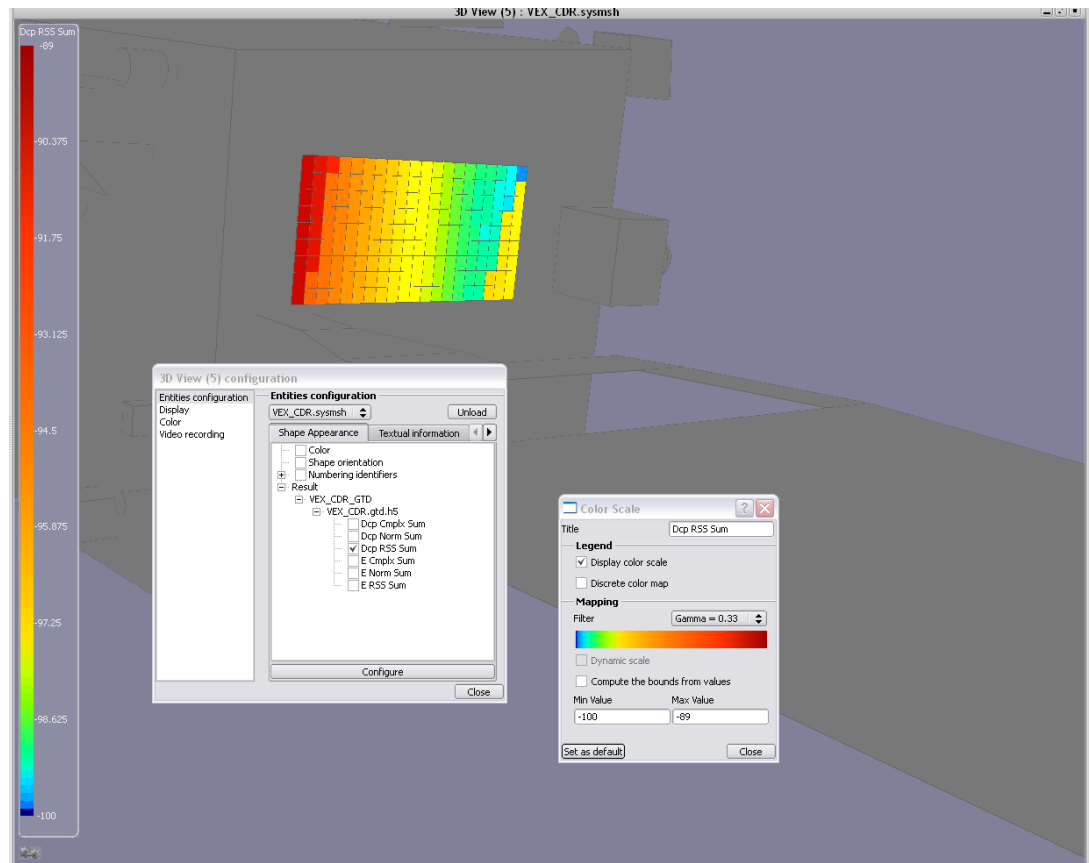

Target Results Mapping

Ray Display

From the 3D configuration view of the meshing, a third category (besides Shape appearance and Textual information) called Ray display is available when a ray display result is loaded in the *Processing* tab.

It is possible to select the rays to display and their properties.

The rays may be display with the following options:

- **All meshes:** Display all rays from the result file
- **By emitting mesh:** Once a mesh is selected, only the rays coming from this mesh are displayed
- **By impacted meshes:** Only rays impacting the selected mesh are displayed. If two or more meshes are selected, the rays displayed are the one going by all of them
- **Between meshes:** produces the same behavior than “by impacted meshes” on GTD ray display

The legend of the rays may also be defined with:

- **No Legend:** In case one of the previous options is directly checked.
- **Decoupling:** The rays are colored depending on their final decoupling contributions. The *Configure* option allows setting the bounds of the scale.
- **Ray Type:** The rays are sorted by ray types (D – diffracted, DD – double diffracted, DR – diffracted and reflected, Dir – direct, R – reflected, RD – reflected and diffracted, RR – double reflected). The *Configure* option allows filtering the ray type to be displayed.

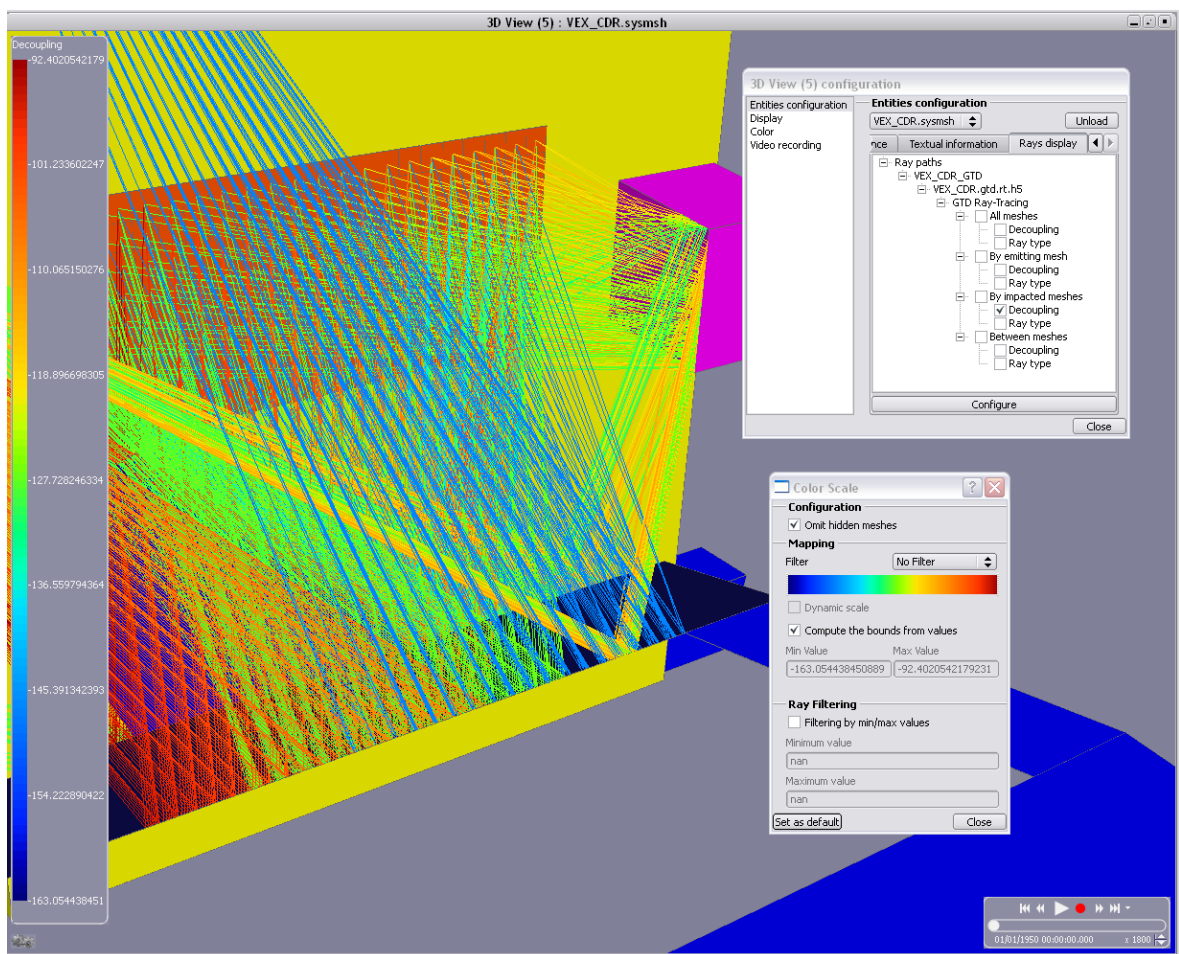

GTD Ray Display

INCA

7 INCA Introduction

What is INCA

The goal is to assess **the E-field inside the spacecraft** cavity due to external antenna radiation and internal RF unit leakages. The following steps shall be studied:

- **External powers at external apertures**
- **Cavity definitions** (surfaces, apertures, materials, RF leaks)
- **E-Field and Power distributions inside cavities**

In this process, the first step may be solved with a **GTD** analysis which returns the power decoupling between the antennas and external apertures defined as targets.

Then, the **INCA** pre-processor analyses the geometry, computes all geometrical data (material areas into each cavity) and exports the mathematical model corresponding to the case. This mathematical model (*mm* file) is then the input required for the **INCA** solver which solves the case and outputs the field and power distributions on the cavities.

The mathematical model is described by a simple and understandable text format. It is then possible to create or modify cases without executing of the **INCA** pre-processor but by editing the input file directly.

The OCT methodology

The proposed methodology is currently used on the Astrium satellites to assess RF E-field inside the cavities. The general principle is to consider the satellite cavity as **multimode cavity** (very large dimensions with respect to operating wavelength), similar to mode stirring chamber (quasi thermodynamic RF conditions, producing homogeneous & isotropic field).

The RF behavior of the satellite internal space corresponds to a multimode or oversized cavity, i.e. intermediate between those of free space and of a resonant cavity. Space attenuation as $E \propto 1/\text{distance}$ or $P \propto 1/\text{distance}^2$, can not be assumed.

The internal volumes of the satellite constitute multimode or oversized cavities, inside which RF **E-fields are statistically homogeneous and isotropic**, i.e. not depending on the measurement location inside the cavity, neither on the polarization or orientation of the E-field (RF power) injected in the cavity by the satellite.

The RF power injected inside the cavity is uniformly attenuated by the presence of the cavity (the power picked up by a receive probe should be independent of the probe location & orientation).

This fixed attenuation, pending on total areas of the internal materials, aperture total areas, and electrical characteristics of these materials (electrical conductivity in S/m & magnetic permeability in H/m), is named **Cavity insertion loss (Xc)**.

This method is valid when the cavity dimensions (few meters for the satellite) are large with respect to the maximum wavelength, so typically for frequencies > 1GHz.

8 INCA Pre-Processor Input Model & Meshing

8.1 The INCA Geometrical Model

Geometry

The geometrical model is used by the **INCA** Pre-Processor to translate it into a mathematical model. The geometry is then mainly used to compute the surface of each material inside each cavity. This surface computation will sum all material surfaces of a cavity, removing eventual surface contacts.

From this Pre-Processor action, we understand that any geometry not adding (or removing) surfaces to a cavity shall not be included into the geometrical model. For example, an equipment modeled by an external box is a part of the cavity definition and shall be kept. However, all geometrical elements that would be included into that box and not seeing the cavity shall be removed from the geometrical description so not to take their surfaces into account in the cavity definition.

Applicative Properties

The INCA properties attached to the geometrical elements are the following:

- **Physical properties:** are composed of the conductivity and permeability of a material. If **SYSTEMA** allows the direct definition of those elements by values, **INCA** requires them to be set by defining the material itself.
- **Surface Area:** Since a cavity may contain geometrical elements seeing the cavity on both sides (pieces of walls for examples), it is necessary to indicate if the surface is involved once (one side only sees the cavity) or twice (both sides see the cavity).

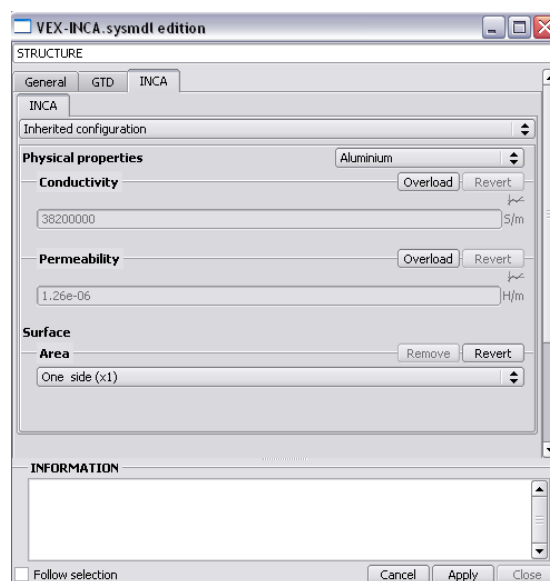

INCA Applicative Properties

Material Database

In order to set the physical properties on the surfaces, it is required to have a material database of materials that may be used in the model. The default material database proposes the definition of Aluminium and Carbon which are the most commonly used ones. If it is required to customize the material database, it is possible to create a new material database (and eventually to copy-paste the materials available from the default database). Then the user can add/remove/modify any material definition. The new created material database shall be saved with native format *sysmtr* and be referenced from the model by editing the root of the geometry, in the INCA tab.

8.2 The INCA Meshing

Geometric Meshing

As for the **GTD** meshing, **INCA** only requires the identification of all shapes but do not need them to be sub-meshed. This part shall then not be modified and left with default values except if the default numbering rules lead to numbering conflicts between different surfaces.

INCA Specific Items

The additional information required to complete the knowledge of the model are:

- **Antennas:** They declare the external sources with frequency and emitted powers. They also indicate the frequencies of internal RF leaks (which usually correspond to frequencies of external antennas).
- **Cavities:** They describe the enclosure of a cavity in order to compute its different material surfaces. RF Leaks are also given for each antenna frequency in dBm (no value corresponding to no leak). It is also possible to add an additional cavity loss to correct the computation of the cavity field if required.
- **Apertures:** They describe the external or internal apertures of the cavities. Indeed they shall reference the cavities on which they belong. It is also possible to add in the referenced objects a geometrical shape in order to remove the area of the aperture to that geometrical element in case the aperture would not have a geometrical existence in the model. The possible aperture types are Rectangle or Circle for which the dimensions are required.

Cavities Definition

To create a cavity, its enclosure shall be defined using a **SYSTEMA** box. The coordinates of this box may be manually entered by values or may be injected (using the arrow icon above the point definition) from the selected point on the geometry (the point selection is available through ALT+Click – a selected point appears as a green dot in the model and its coordinates are written in the bar at the bottom of the modeler tab).

All the shapes belonging (totally or partially) to the cavity will be taken into account for the material surfaces computation. If a surface is partially included into a cavity, an inclusion ratio is computed in order to compute the correct area inside the cavity.

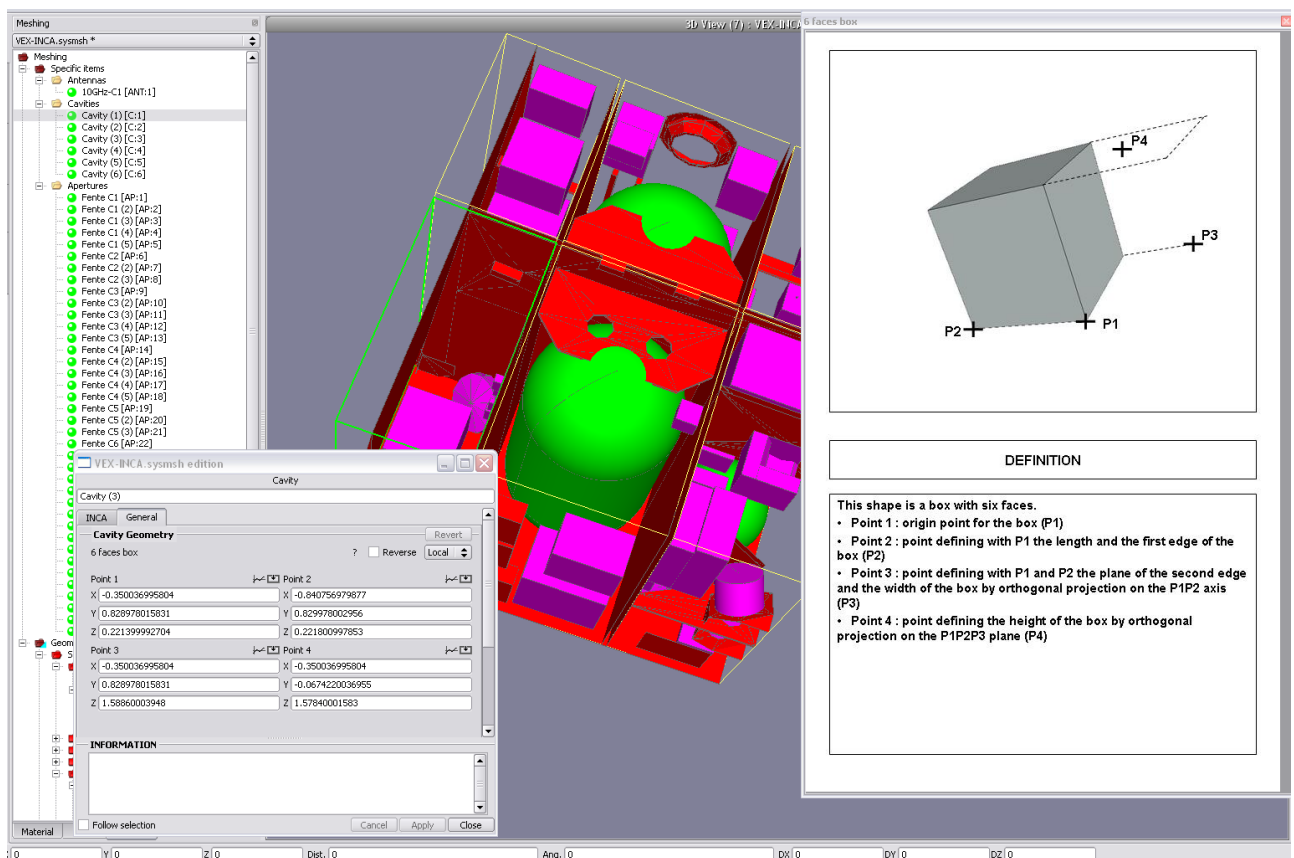

INCA Cavity definition

Apertures Definition

An aperture is not defined by a geometrical element. Also the applicable formulas for apertures radiation pattern are only known for circle and rectangle. As a consequence, apertures can not be guessed automatically by the software and need to be defined. The exact position of an aperture has no importance for the OCT computation so only the geometrical parameters and the cavity references shall be specified.

The areas of materials within the cavity are computed from their geometrical definitions. The aperture geometry is by default not removed, supposing that the aperture has a geometrical existence in the model. In case the aperture does not exist on the geometry (for example the cavities are made by boxes without holes), it is also possible to reference a shape on which the area shall be subtracted.

9 INCA Pre-Processor Analysis

9.1 The INCA Pre-processor Process

As for the GTD Process, the computation process can be set and executed from the *Processing* tab of **SYSTEMA**.

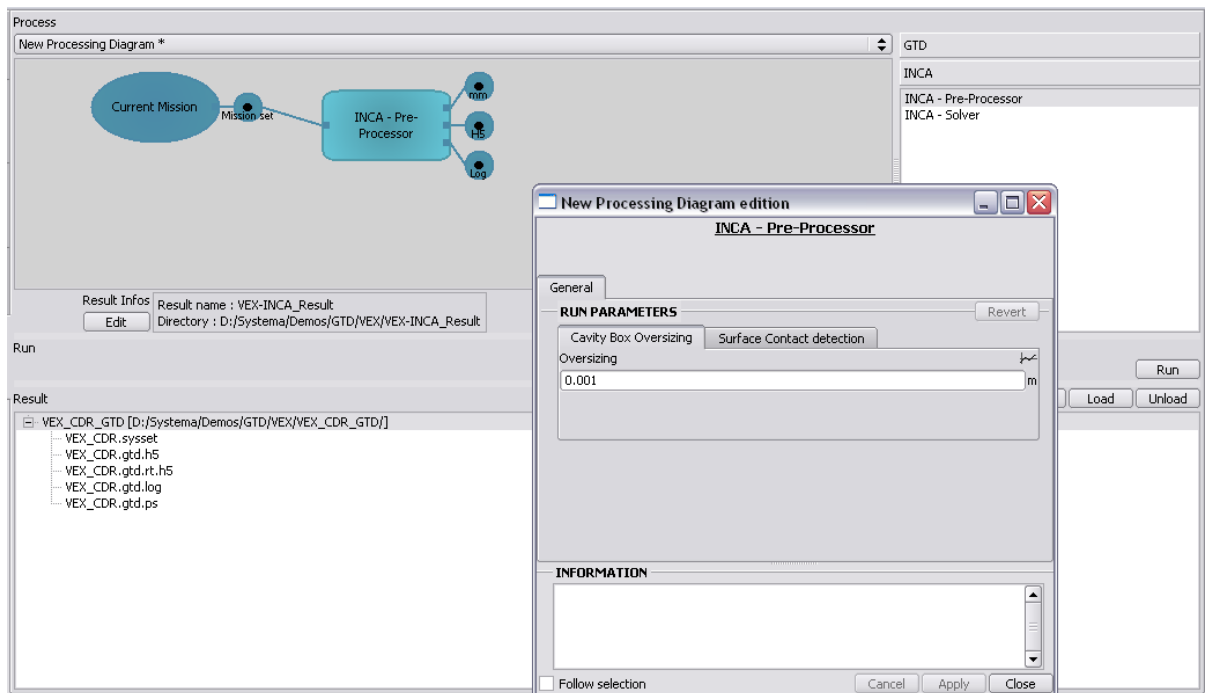

INCA Pre-Processor

The available options of the **INCA Pre-Processor** module are:

- **Cavity Box Over-sizing:** Gives the small tolerance for the detection of shapes within a cavity. Due to accuracy matters, if the box has been exactly set from cavity corners, it is recommended to let a small value on this option (at least 0.00001 meter)
- **Surface Contact Detection:** Specifies the number of rays used by the surface to detect any contact. The threshold is the distance tolerance to detect contact or not.

9.2 Outputs

The **INCA Pre-Processor** outputs are:

- **INCA Mathematical Model:** this file is the text description of the model to be solved by the OCT. The format of this file is explained in the next section.
- **Log:** summarizes information about the computation data for execution checking.
- **H5:** contains the cavity references found by the pre-processor in the hdf5 format for post-processing.

9.3 Post-Processing the results

From the modeler tab it is possible to check the surface/cavity references computed by **INCA**. The area ratios of each shape relative to a cavity are then displayed.

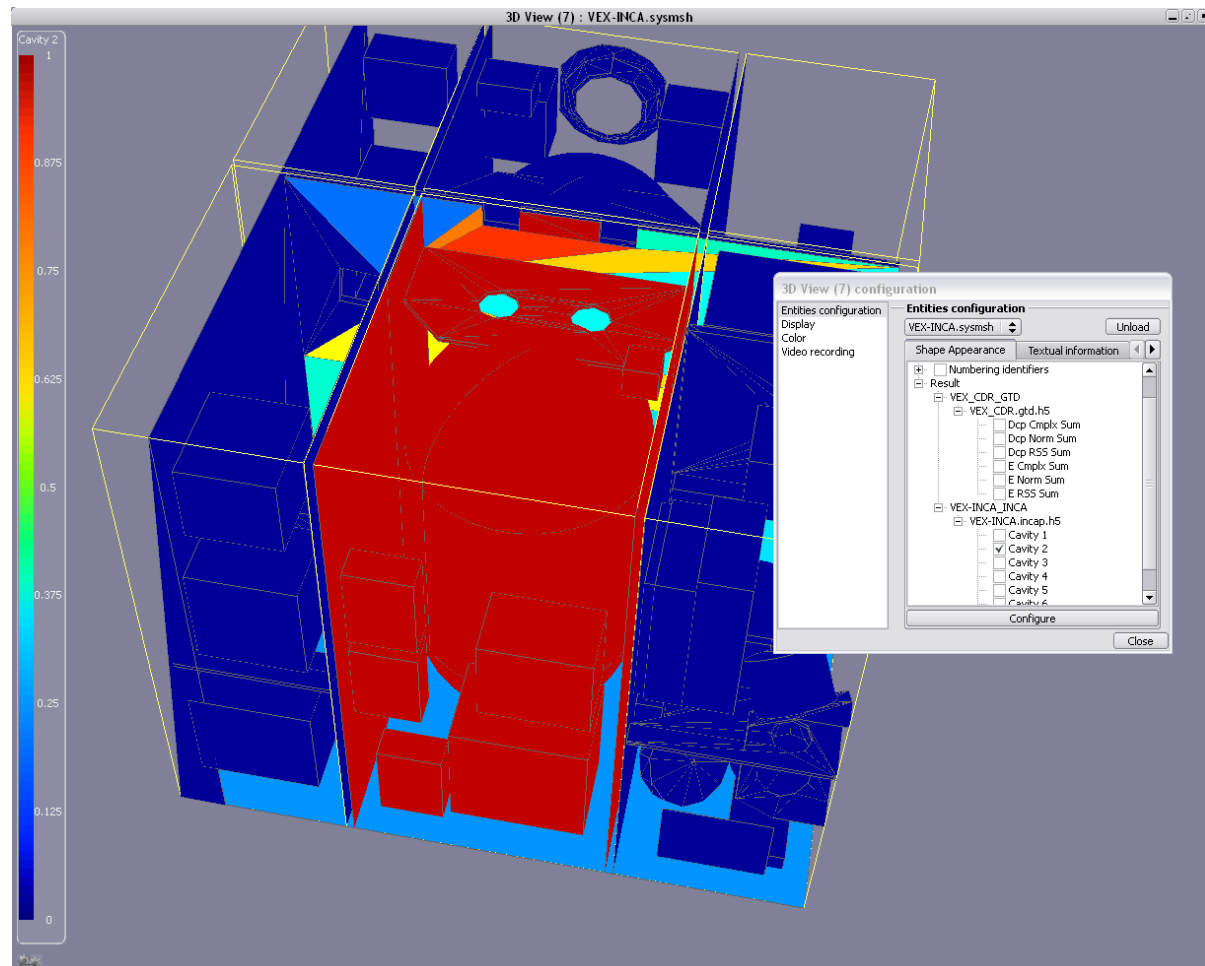

INCA Cavity References Post-Processing

10 INCA Solver Input

10.1 The INCA Mathematical Model

The **INCA** mathematical model is a textual description of the model to be solved including blocks for antenna, materials, cavities and apertures definitions. This language allows to create or modify cases and to run them in batch command.

Model Overview

If the edition/creation of a mathematical model is required, it is always possible to use the **INCA Pre-Processor** module in order to generate a valid example. Here is a complete file produced by this module:

```
#*****#
#
#          INCA Mathematical Model          #
#
#*****#
#  Generated on : Wed Jun 22 14:26:35 2011

$MODEL A3B_SIMPLE

$ANTENNAS
# Declaration Bloc of External Sources (Antennas) :
#          name          frequency (GHz)          power (dBW)

ANT1 = 'Antenna (1)', Freq = 10, Power = 22;

$MATERIALS
# Declaration Bloc of Materials :
#          name          permeability (H/m)          conductivity (S/m)

MAT1 = 'Aluminium', Mu = 3.82e+07, Sigma = 1.26e-06;
MAT2 = 'Carbon', Mu = 71400, Sigma = 1.26e-06;

$CAVITIES
# Declaration Bloc of Cavities :
#          name
#          surface (for each material) (m²)
#          power leak (for each frequency) (dBm)
#          loss correction (dB)

C1 = 'UPPER_CM', Surf(MAT1) = 14.4358, Surf(MAT2) = 0, Leak(ANT1)=5, Correction=-1;
C2 = 'CM_Low_+X-Y', Surf(MAT1) = 14.7113, Surf(MAT2) = 1.50303;
C3 = 'CM_Low_+X+Y', Surf(MAT1) = 14.7034, Surf(MAT2) = 1.50303;
C4 = 'CM_Low_-X+Y', Surf(MAT1) = 14.712, Surf(MAT2) = 1.50303;
C5 = 'CM_Low_-X-Y', Surf(MAT1) = 14.712, Surf(MAT2) = 1.50303;
C6 = 'SM_-X-Y', Surf(MAT1) = 3.89064, Surf(MAT2) = 0.35872;
C7 = 'SM_+X-Y', Surf(MAT1) = 3.89064, Surf(MAT2) = 0.35872;
C8 = 'SM_+X+Y', Surf(MAT1) = 3.89064, Surf(MAT2) = 0.35872;
C9 = 'SM_-X+Y', Surf(MAT1) = 3.89848, Surf(MAT2) = 0.35872;

$APERTURES
# Declaration Bloc of Apertures :
#          name
#          type (rectangle with a,b,thickness - Circle with r,thickness) (m)
#          for each antenna (if external aperture) :
#          - decoupling          attenuation          margin          (dB)

AP1(C1,C2) = 'Internal Aperture (1)', Type = Circle(0.05, 0.025);
AP2(C1,C3) = 'Internal Aperture (2)', Type = Circle(0.05, 0.025);
AP3(C1,C4) = 'Internal Aperture (3)', Type = Circle(0.05, 0.025);
AP4(C1,C5) = 'Internal Aperture (4)', Type = Circle(0.05, 0.025);
```

```

AP5(C2,C3) = 'Internal Aperture (5)',      Type = Circle(0.1, 0.02);
AP6(C2,C5) = 'Internal Aperture (6)',      Type = Circle(0.1, 0.02);
AP7(C3,C4) = 'Internal Aperture (7)',      Type = Circle(0.1, 0.02);
AP8(C4,C5) = 'Internal Aperture (8)',      Type = Circle(0.1, 0.02);
AP9(C2,C7) = 'Internal Aperture (9)',      Type = Circle(0.1, 0.02);
AP10(C3,C8) = 'Internal Aperture (10)',    Type = Circle(0.1, 0.02);
AP11(C4,C9) = 'Internal Aperture (11)',    Type = Circle(0.1, 0.02);
AP12(C5,C6) = 'Internal Aperture (12)',    Type = Circle(0.1, 0.02);
AP13(C6,C7) = 'Internal Aperture (13)',    Type = Circle(0.1, 0.02);
AP14(C6,C9) = 'Internal Aperture (14)',    Type = Circle(0.1, 0.02);
AP15(C7,C8) = 'Internal Aperture (15)',    Type = Circle(0.1, 0.02);
AP16(C8,C9) = 'Internal Aperture (16)',    Type = Circle(0.1, 0.02);

AP17(C3) = 'External Aperture (1)',        Type = Circle(0.1, 0),
      Dcp(ANT1) = -80,   Att(ANT1) = -10,   Mrg(ANT1) = 5;

```

\$ENDMODEL

\$ANALYSIS

ANT1;

Generic rules of the MM format

The model is composed of a main block called \$MODEL which contains descriptive blocks for the declaration of Antennas, Materials, Cavities and Apertures. The blocks shall be always declared in this order because of dependencies.

A last block called \$ANALYSIS indicates for which antenna frequencies the **INCA Solver** shall compute the E-field.

The file format is not case sensitive and is free (no column specifications).

Comments may be added anywhere by using the # character. Anything placed between # and a line return is considered as comments.

In each declaration block, an entity is declared by using its reserved name (ANT, MAT, C, AP) and a number. The numbers used may not be a sequential list but any custom numbers as long as the same identifier is not used twice. Indeed, an entity may be removed without necessary correct all the other entities numbering.

A declaration always ends by a semi coma character.

Whenever an entity depends on another one, the dependence is placed between brackets. For example, the declared surface for each material in a cavity is written Surf(MAT n) or an aperture between 2 cavities is written AP k (C n ,C m).

If a property is not declared, its natural value is equal to zero. For example if a surface material is not written in a cavity definition, it means that this material has a zero area in this cavity. For properties having a logarithmic unit, setting a zero natural value (-infinite in logarithmic definition) is possible by removing them from the list.

Antennas

The antennas declare the external sources and their frequencies. The computation of internal E-Field will be made for each individual antenna frequency. Indeed, 2 antennas working at the same frequency will lead to 2 distinct computations.

Antennas can then also be seen as computation cases.

Materials

Defines the materials used in the cavities with their properties (permeability and conductivity)

Cavities

A cavity is mainly defined by its effective surface classified by material kinds. It is also possible to define the RF leak powers (in dBm) due to internal RF units at the antenna frequencies.

An additional loss correction (negative value in dB) may also be used to decrease the computed E-Field of a cavity in case sources of attenuations are not correctly modelled by material absorptions or external apertures. For example a correction of -2dB will subtract 2dB to the cavity insertion loss factor Xc (see §11.4 for more details on this parameter).

Apertures

An aperture links either 2 cavities (internal apertures) or one cavity to space (external apertures). It is defined by its geometrical description (rectangle or circle).

For external apertures, the decoupling, attenuation and margin, expressed in dB, with each antenna may be defined.

The decoupling shall always be a negative value, meaning that its effect is to decrease the power at the aperture level compared to the external antenna source power.

The attenuation is also a negative value which decreases the level of received power at the aperture, useful to model for example a MLI shielding effect.

The margin is however a positive value which has for effect to increase the level of received power.

11 INCA Solver Analysis

11.1 The INCA Solver Process

The *Solver* process may be used from the **SYSTEMA** interface directly after the *Pre-Processor* by linking the mm output of the *Pre-Processor* to the mm input of the *Solver*.

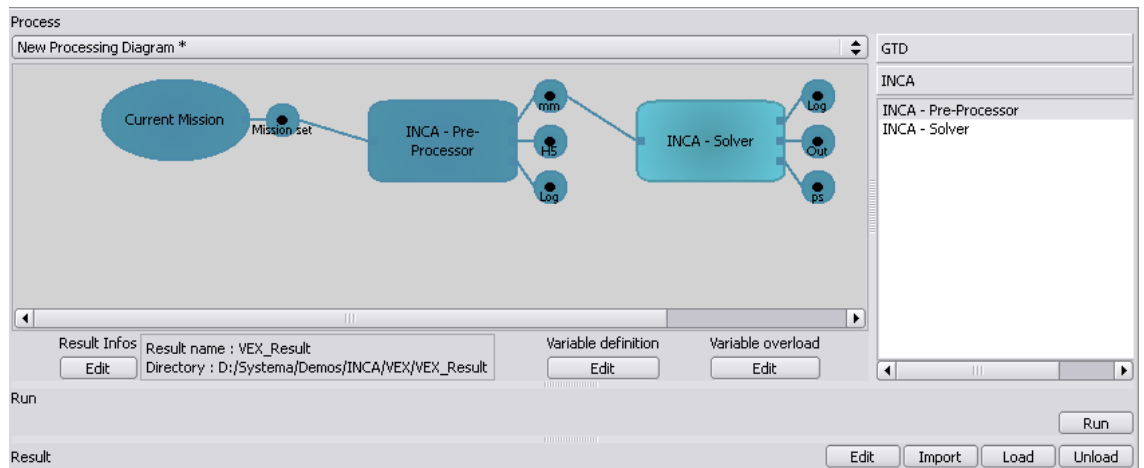

The link can be done by a drag and drop from the join icon (top right symbol of the file icon which appears when the mouse is over it)

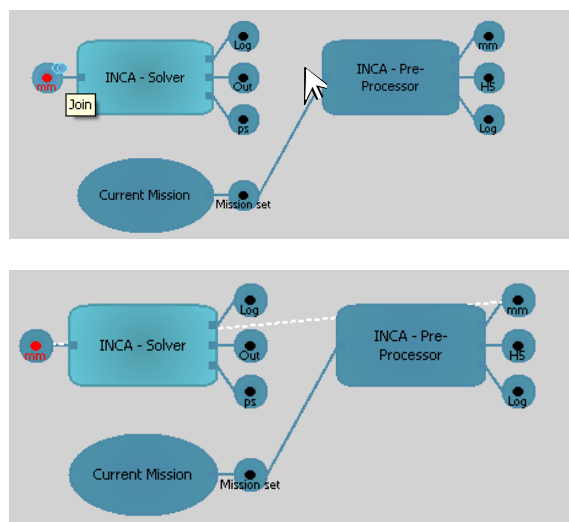

It is also possible to create a process diagram with the **INCA Solver** only. In that case the mm input shall be edited to reference the file to be used.

The **INCA Solver** has no particular properties to be set since all data is already contained in the mm file.

Another possibility is to execute in batch command the *Solver*. This may be done with the following command line:

On Windows:

```
%SYSTEMA_HOME%\applications\INCA-4.4.2\incaSolverWIN.exe -mm [input file]
```

On Linux:

```
$SYSTEMA_HOME/applications/INCA-4.4.2/incaSolverLNX -mm [input file]
```

11.2 The INCA Solver Outputs

The outputs of the Solver are composed of 3 files:

- **Log file:** Contains the execution summary. The input model is first re-written in order to check that it has been read correctly by the program. All data are given in natural values. Then, for each analysis case (i.e. for each declared antenna), the steps of the resolution are given including all intermediate data (skin depth of materials, cut-off frequencies and normalized surfaces of apertures, conductive and radiative components of cavities...). Finally, the solution of the system is given as a table:

```
Solution of System:
-----
```

	Power (dBm)				E-Field (dBV/m)			
	Average	Minimum (0.1%)	Maximum (99.9%)	Mean (50%)	Average	Minimum (0.1%)	Maximum (99.9%)	Mean (50%)
- Cavity 1	-28.2	-58.2	-19.9	-29.8	12	0.1	17.7	11.5
- Cavity 2	-32.2	-62.1	-23.9	-33.7	8.03	-3.9	13.7	7.6
- Cavity 3	-36.2	-66.1	-27.8	-37.7	4.07	-7.8	9.8	3.6
- Cavity 4	-36.7	-66.6	-28.3	-38.2	3.57	-8.4	9.2	3.1
- Cavity 5	-34.1	-64.1	-25.8	-35.7	6.08	-5.8	11.8	5.6
- Cavity 6	-31	-60.9	-22.6	-32.5	9.25	-2.7	14.9	8.8

Then a power budget is given by cavity plus the total budget in order to check the radiative and conductive effective contributions.

The functions given in the next post-script file are also given in a table value in case plots may be done in another tool.

- **Out file:** Summarizes the results in antennas / cavities tables. Values are given in both natural and logarithmic format for average powers, maximum powers (99.9% of the cumulative functions), average E-Field and maximum E-Field at 99.9%.
- **PS file:** Contains the probability densities and cumulative functions for each cavity and case in a post-script format. The average values correspond to the probability density maximum. The 50% means, marked with the dash line, correspond to the 50% of the cumulative distribution.

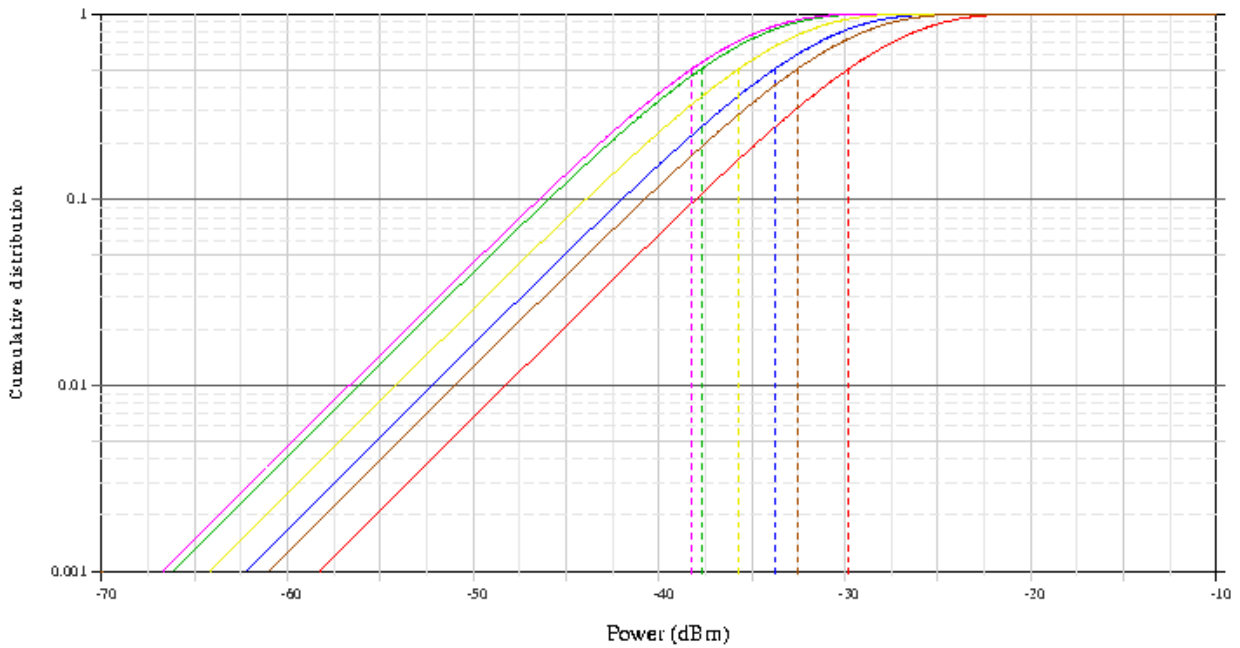
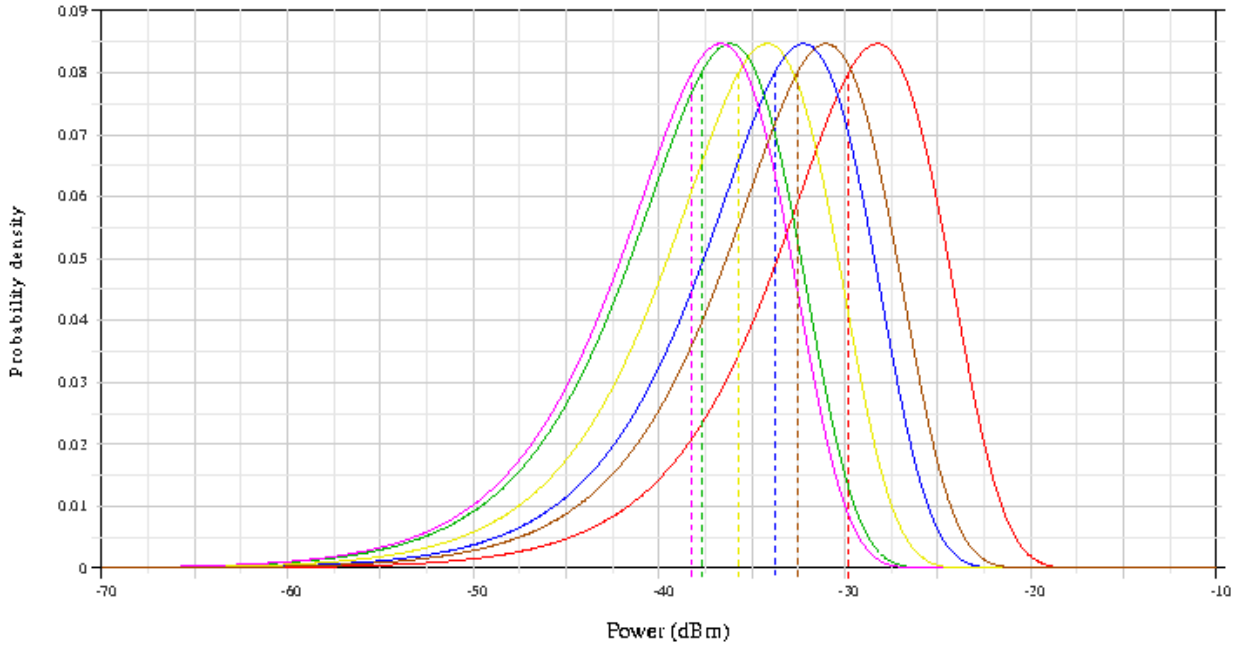

10GHz-C1 - VEX-INCA - Cumulative distribution of Pr	
Description	Description
<ul style="list-style-type: none"> ■ Cavity 1 'Cavity (1)' <Pr>= -28 min= -58 max= -30 mean=-29.8 dBm ◆ Cavity 3 'Cavity (3)' <Pr>= -36 min= -66 max= -28 mean=-37.7 dBm ▲ Cavity 5 'Cavity (5)' <Pr>= -34 min= -64 max= -36 mean=-35.7 dBm 	<ul style="list-style-type: none"> ■ Cavity 2 'Cavity (2)' <Pr>= -32 min= -62 max= -24 mean=-33.7 dBm ◆ Cavity 4 'Cavity (4)' <Pr>= -37 min= -67 max= -28 mean=-38.2 dBm ▲ Cavity 6 'Cavity (6)' <Pr>= -31 min= -61 max= -23 mean=-32.5 dBm

Generated by TICA v4.4.0, ASTRIUM SAS - 2010 - All rights reserved

12 INCA Theoretical Background

12.1 Injected Power through Apertures

Injected Power

The power injected in a spacecraft cavity by the back-radiation of an external transmit antenna through an aperture is given by the following formula:

$$P_{in}(W) = \frac{4\pi}{\lambda^2} \cdot P_{ant} \cdot 10^{\frac{D+Att+Mrg}{10}} \cdot S_n \cdot S(m^2) \left| e^{-2\gamma \cdot e} \right|$$

Where:

P_{in} : power injected from an antenna into the cavity by one aperture (W)

P_{ant} : output power from the external transmit antenna (W)

D : decoupling value between emission antenna and aperture (dB)

Att : attenuation coefficient of the aperture (dB)

Mrg : additional margin on the aperture (dB)

S_n : normalized aperture effective area (no unit)

S : physical area of the aperture (m²)

$|e^{-2\gamma e}|$: equivalent waveguide attenuation

γ : propagation constant

e : thickness

Circular Aperture

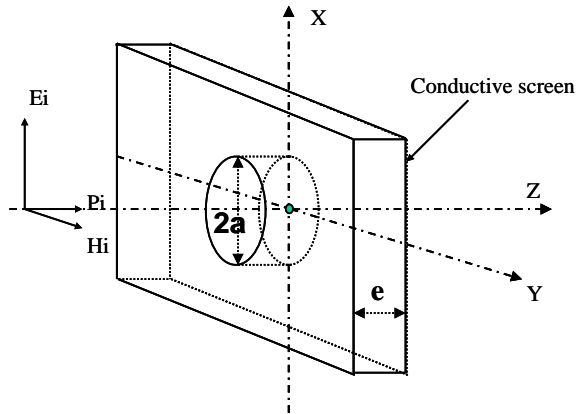

Definition of the normalised aperture effective area

The following formula gives a good approximation for both small and large circular apertures. It is based on two functions: the transfer function of a fourth order high pass filter and the transfer function of a second order pass band filter.

$$S_n = \left(\frac{1}{1 + \frac{1}{\alpha} \left(\frac{f_c}{f} \right)^4} \right) \left(\frac{2}{\sqrt{1 + 16 \left(\frac{f}{f_c} - 1 \right)^2}} + 1 \right)$$

with $f_c = \frac{1.84c}{2\pi a}$ (cut-off frequency of TE₁₁ mode) and $\alpha = 1.85$

The next figure shows the “S_n” factor for a circular aperture with a radius = 1.5cm.

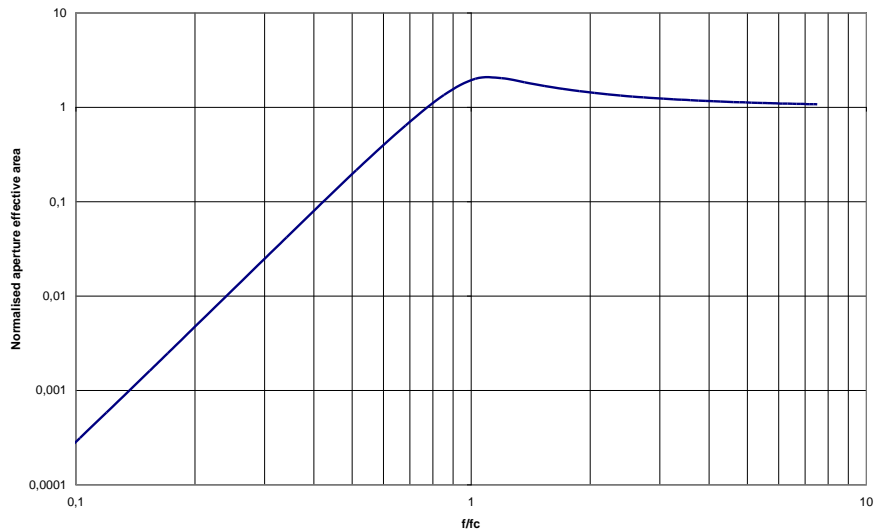

Normalized aperture effective area of a circular aperture

The peak value is about 2 at the resonance frequency which is consistent with the literature on the subject.

Definition of the equivalent waveguide attenuation

In a waveguide, we find the Transverse Magnetic waves (TM waves) and the Transverse Electric waves (TE waves). Each mode is entirely defined by a couple of integer (m,n) which is called TM_{mn} or TE_{mn} .

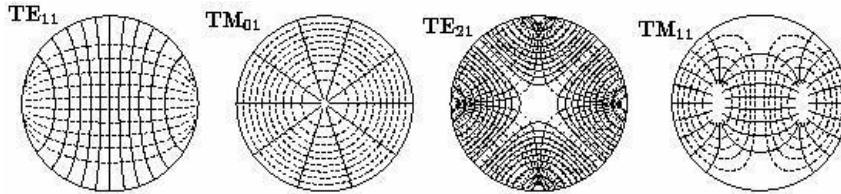

The power attenuation in a waveguide of thickness “e” is given by the formula $|e^{-2\gamma e}|$ with γ = propagation constant. The attenuation is produced if γ is real.

The propagation constant is equal to zero for a single value f_c called the cut-off frequency.

The wave that has the lower cut-off frequency is the wave that has the lower attenuation. This wave is called the dominant wave. For a circular aperture, the dominant wave is the

TE_{11} and its cut-off frequency is equal to : $f_c = \frac{1.84c}{2\pi a}$

For all frequencies f such that $f < f_c$, γ is real and is equal to: $\gamma = \frac{\omega}{c} \sqrt{\left(\frac{f_c}{f}\right)^2 - 1}$

For frequencies $f > f_c$: the wave is propagated in the waveguide so the attenuation is fixed to 0dB.

The next figure illustrates the circular waveguide attenuation for a thickness of 2cm.

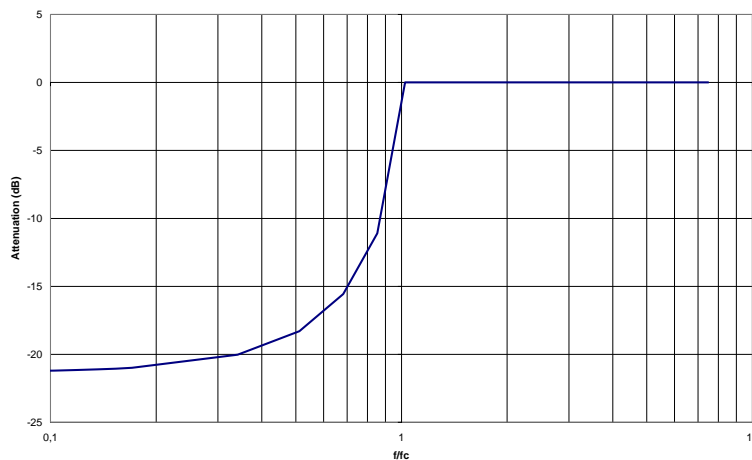

Circular waveguide attenuation

Rectangular Aperture

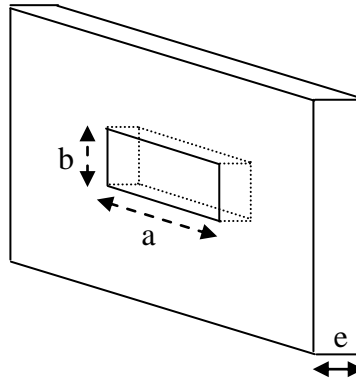

Definition of the normalised aperture effective area

For rectangular apertures, the normalized effective area is :

$$S_n = \left(\frac{1}{1 + \left(\frac{f_c}{f}\right)^4} \right) \left(\frac{2 \cdot \frac{a}{b}}{\sqrt{1 + \frac{4}{\alpha} \cdot \left(\frac{a}{b}\right) \cdot \left(\frac{f}{f_c} - 1\right)^2}} + 1 \right)$$

with: $f_c = \frac{c}{2a}$ (cut-off frequency of TE₀₁ mode).

$$\alpha = \begin{cases} 1 & \text{if } a/b < 30 \\ 0.47 \cdot \frac{\frac{a}{b}}{\left[\ln\left(4 \cdot \frac{a}{b}\right) - 1 \right]^2} & \text{if } a/b \geq 30 \end{cases}$$

Definition of the equivalent waveguide attenuation

For a rectangular aperture, the dominant wave is the TE₀₁ and its cut-off frequency is equal

$$\text{to: } f_c = \frac{c}{2a}$$

For all frequencies f such that $f < f_c$, γ is real and is equal to: $\gamma = \frac{\omega}{c} \sqrt{\left(\frac{f_c}{f}\right)^2 - 1}$

For frequencies $f > f_c$: the wave is propagated in the waveguide so the attenuation is fixed to 0dB.

The figure here below illustrates the normalized aperture effective area and the waveguide attenuation for a rectangular aperture equal to: a = 10cm , b=2cm ; e =2cm.

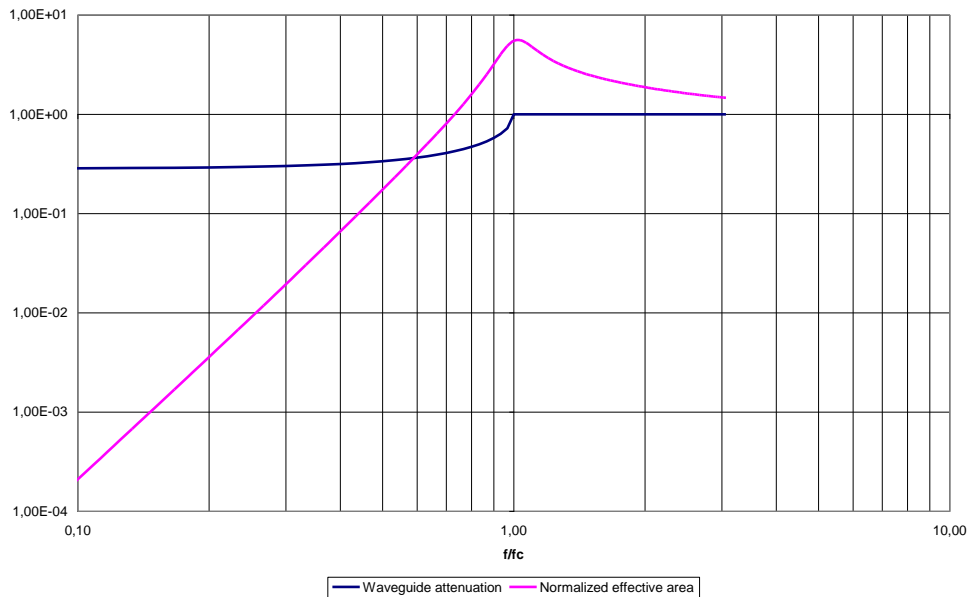

Waveguide attenuation and normalized effective area for a rectangular aperture

12.2 Cavity insertion loss assessment

The cavity insertion loss **Xc** is a combination of a radiative component **Xr** due to loss by apertures and a conductive component **Xσ** due to loss in the material:

$$\frac{1}{Xc} = \frac{1}{Xr} + \frac{1}{X\sigma}$$

With:

$$\frac{1}{Xr} = \frac{1}{2} \cdot \frac{8 \times \pi}{\lambda^2} \cdot \sum_{i=1}^{N_{ap}} Sap_i \cdot Sn_i \cdot |e^{-2\gamma_e}|$$

$$\frac{1}{X\sigma} = \frac{4}{3} \cdot \frac{8 \times \pi^2}{\lambda^3} \cdot \sum_{i=1}^{N_{mat}} Sm_i \cdot \delta_i$$

Where:

λ : wavelength in free space

Sm_i : total internal cavity surface for the material i

Sap_i : apertures surface in m²

Sn_i : normalized aperture effective area (no unit)

δ_i : skin depth for the material i , $\delta = \frac{1}{\sqrt{\pi \times f \times \sigma_i \times \mu_i}}$

f : frequency in free space

σ_i : electric conductivity for the material i

μ_i : magnetic permeability for the material i

Received power assessment in one cavity

The analytical method mentioned here above allows assessing the **average field/power** in a give area. In order to assess the E-field distribution (min, max, average) in such complex environment, a statistical description is the only **meaningful** one (if not the only possible).

Transfer functions are extremely complex and very sensitive to variations, whereas the EM statistical approach depends only on general properties of the system and enables:

- to treat the problem of interior responses of complex systems,
- to examine the probability of the system's performance with good accuracy if we take care of statistical parameters needed.

Generally, a statistical model consists in using a mathematical function called distribution. It exists many types of distributions and associated analytical formulas. Only few of them can be use to describe with a good fit the EM behavior inside a complex cavity when the excitation comes from inside or outside the cavity. The distribution which gives the probability densities of the power in natural value inside a high-frequency and complex cavity is an "exponential distribution", named also "Chi-Squared distribution. If the results are given in dBm, or in power ratio in dB, the appropriate distribution is an "Extreme value distribution" named also "Gumbel" distribution.

The **average received power** $\langle P_r \rangle$ is linked to the cavity insertion loss by the following formula:

$$\frac{\langle P_r \rangle}{P_{in}} = X_c$$

Where X_c is the cavity insertion factor and P_{in} is the emission power.

It was shown that the received power expressed in dBW or dBm follows a Gumbel distribution. The probability density function of P_{rdB} is:

$$f_{P_{rdB}}(P_{rdB}) = \frac{1}{\beta} \exp \left[\frac{P_{rdB} - \langle P_r \rangle_{dB}}{\beta} - \exp \left(\frac{P_{rdB} - \langle P_r \rangle_{dB}}{\beta} \right) \right]$$

Where $\beta = \frac{10}{\ln 10}$ and $\langle P_r \rangle_{dB} = 10 \log \langle P_r \rangle$

The cumulative distribution function of P_{rdB} is:

$$F_{P_{rdB}}(P_{rdB}) = 1 - \exp\left[-\exp\left(\frac{P_{rdB} - \langle P_r \rangle_{dB}}{\beta}\right)\right]$$

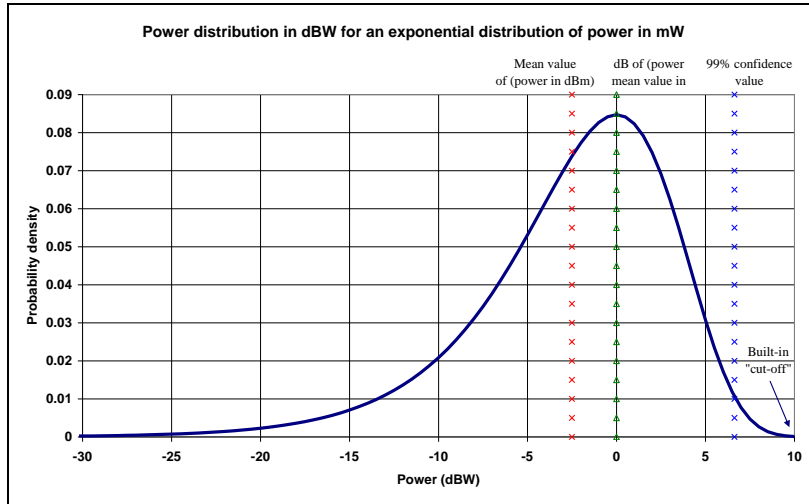

Probability density function of P_{rdB} for $\langle P_r \rangle_{dB} = 0$ dBm

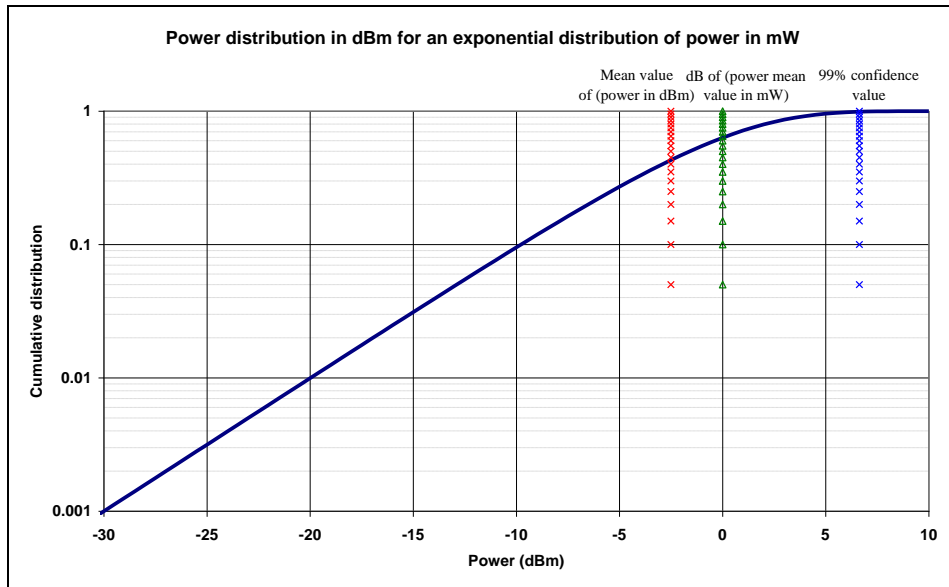

Cumulative distribution function of P_{rdB} for $\langle P_r \rangle_{dB} = 0$ dBm

The consequence is that for a given calculated $\langle P_r \rangle$, the actual $P_{r,dBm}$ may be a P_{max} and a P_{min} if one excludes the 0.1% of cases respectively higher and lower than this range.

Received E-field assessment in one cavity

The average power received by a matched antenna is:

$$\langle P_r \rangle = \frac{\langle E^2 \rangle \lambda^2}{\eta \cdot 8\pi} \text{ with } \eta = \mu_0 c \approx 120\pi$$

Note that the antenna gain does not play any role.

The **average electric field** $\langle E \rangle$ is linked to the cavity insertion loss by the following formula:

$$\langle E \rangle = \frac{\sqrt{P_e \cdot X_c}}{\lambda} \cdot \sqrt{\frac{15 \times 75 \times \pi^3}{4}} \approx \frac{4\pi}{\lambda} \cdot \sqrt{60 \cdot P_e \cdot X_c}$$

Where X_c is the cavity insertion factor and P_{in} is the emission power.

It was shown that the electric field E expressed in dB or the E^2_{dB} follows the same distribution:

$$f_{E^2_{dB}}(E^2_{dB}) = \frac{1}{2\beta} 3^3 \exp\left(\frac{3(E^2_{dB} - \langle E^2 \rangle_{dB})}{\beta}\right) - 3 \exp\left(\frac{E^2_{dB} - \langle E^2 \rangle_{dB}}{\beta}\right) \text{ with } \beta = \frac{10}{\ln 10}$$

This is summarised on the following graph:

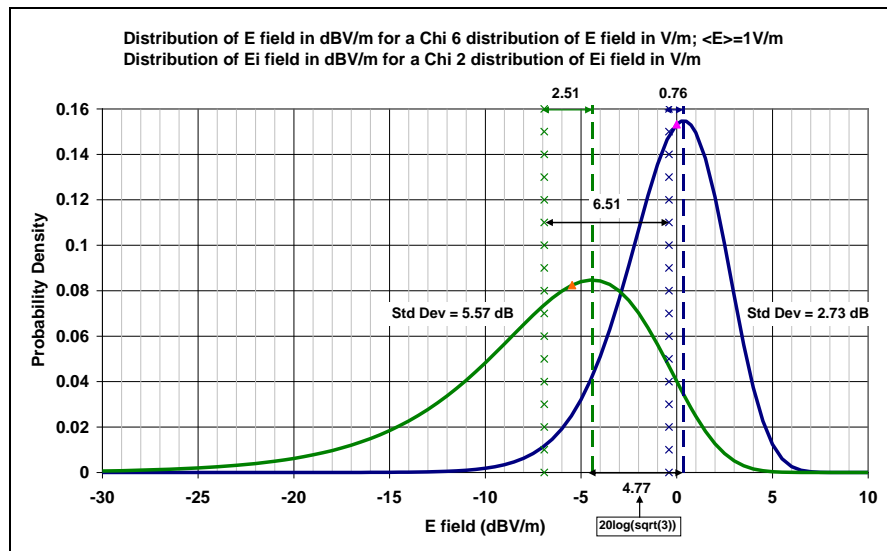

Probability density function of $E^2_{i_{dB}}$ or $E_{i_{dB}}$ and E^2_{dB} or E_{dB}

For a given calculated $\langle E \rangle$, the actual $E_{dBV/m}$ may be between E_{max} and E_{min} if one excludes the 0.1% of cases respectively higher and lower than this range.

Received Power assessment in several cavities

The power inside a cavity i is equal to the sum of all powers getting in minus the sum of all powers getting out of the cavity:

$$\langle \mathbf{Pr}_i \rangle = P_{in} - P_{out}$$

The power getting out of the cavity is by definition of the insertion loss equal to:

$$P_{out} = \langle \mathbf{Pr}_i \rangle \cdot X_{ci}$$

The power getting in a cavity comes from external powers at external apertures, internal RF leaks and from the powers getting out of adjacent cavities j .

$$P_{in} = P_{ext} + P_{int} + \sum_j \frac{1}{2} \cdot \frac{8\pi}{\lambda_0^2} \cdot S_{ij} \cdot \langle \mathbf{Pr}_j \rangle$$

Where the external powers are:

$$P_{ext} = \sum_{\substack{ap=\text{External Apertures} \\ ant=\text{External Antennas}}} \frac{P_{ant}}{D_{ant,ap}} \cdot \frac{1}{2} \cdot \frac{8\pi}{\lambda_0^2} \cdot S_{ap}$$

With $D_{ant,ap}$ the total decoupling between the antenna and the aperture, taking into account attenuations and margins, and S_{ap} the normalized external aperture surface taking into account its thickness attenuation.

The power budget of a cavity then becomes:

$$\langle \mathbf{Pr}_i \rangle = P_{ext} + P_{int} + \sum_j \frac{4\pi}{\lambda_0^2} \cdot \langle \mathbf{Pr}_j \rangle \cdot S_{ij} - \langle \mathbf{Pr}_i \rangle \cdot X_{ci}$$

$$(1 + X_{ci}) \langle \mathbf{Pr}_i \rangle - \sum_j \frac{4\pi}{\lambda_0^2} \cdot S_{ij} \cdot \langle \mathbf{Pr}_j \rangle = P_{ext} + P_{int}$$

The full system based on n cavity power budgets equilibrium can be therefore written by the following symmetric matricial system:

$$\begin{bmatrix} 1 + X_{c1} & & & & & \\ & \ddots & & & & \\ & & & -\frac{4\pi}{\lambda_0^2} \cdot S_{ij} & & \\ & & & & 1 + X_{ci} & \\ & & -\frac{4\pi}{\lambda_0^2} \cdot S_{ij} & & & \ddots \\ & & & & & & 1 + X_{cn} \end{bmatrix} \bullet \begin{bmatrix} \langle \mathbf{Pr}_1 \rangle \\ \vdots \\ \langle \mathbf{Pr}_i \rangle \\ \vdots \\ \langle \mathbf{Pr}_n \rangle \end{bmatrix} = \begin{bmatrix} (P_{int} + P_{ext})_1 \\ \vdots \\ (P_{int} + P_{ext})_i \\ \vdots \\ (P_{int} + P_{ext})_n \end{bmatrix}$$

The different powers in each cavity are computed by resolving the matrix here above.